

**COMPARISON BETWEEN MODEL PREDICTIVE CONTROL AND PID CONTROL  
FOR WATER-LEVEL MAINTENANCE IN A TWO-TANK SYSTEM**

by

**Ang Li**

BS in Information Engineering, University of Science and Technology, Beijing, 2008

Submitted to the Graduate Faculty of  
The Swanson School of Engineering in partial fulfillment  
of the requirements for the degree of  
Master of Science

University of Pittsburgh

2010

UNIVERSITY OF PITTSBURGH  
SWANSON SCHOOL OF ENGINEERING

This thesis was presented

by

Ang Li

It was defended on

June 21, 2010

and approved by

Zhi-Hong Mao, PhD, Assistant Professor, Electrical and Computer Engineering Department

Ching-Chung Li, PhD, Professor, Electrical and Computer Engineering Department

Mingui Sun, PhD, Neurological Surgery Department

Thesis Advisor: Zhi-Hong Mao, PhD, Assistant Professor, Electrical and Computer  
Engineering Department

Copyright © by Ang Li

2010

**COMPARISON BETWEEN MODEL PREDICTIVE CONTROL AND PID  
CONTROL FOR WATER-LEVEL MAINTENANCE IN A TWO-TANK SYSTEM**

Ang Li, M.S.

University of Pittsburgh, 2010

The objective of this study is to investigate the Model predictive control (MPC) strategy, analyze and compare the control effects with Proportional-Integral-Derivative (PID) control strategy in maintaining a water level system. An advanced control method, MPC has been widely used and well received in a wide variety of applications in process control, it utilizes an explicit process model to predict the future response of a process and solve an optimal control problem with a finite horizon at each sampling instant.

In this thesis, we first designed and built up a closed-loop two-tank water level system. Next, we modeled the system and linearized the model for simplification in the analysis and design. Then, we implemented the model in a simulation environment based on Matlab. We tried both MPC and PID control methods to design the controller for the two-tank system, and compared the results in terms of settling time, overshoot, and steady-state error under various operational conditions including time delays. The results showed the advantage of MPC for dealing with the system dynamic over PID and could be designed for more complex and fast system dynamics even in presence of constraints.

## TABLE OF CONTENTS

<b>LIST OF TABLES .....</b>	<b>VII</b>
<b>LIST OF FIGURES .....</b>	<b>VIII</b>
<b>1.0 INTRODUCTION.....</b>	<b>1</b>
<b>1.1 BACKGROUND OF MODEL PREDICTIVE CONTROL .....</b>	<b>2</b>
<b>1.2 MOTIVATION .....</b>	<b>4</b>
<b>2.0 EXPERIMENT DESCRIPTION.....</b>	<b>5</b>
<b>2.1 WATER TANK SYSTEM .....</b>	<b>5</b>
<b>2.2 MATHEMATICAL MODEL OF WATER TANK SYSTEM .....</b>	<b>7</b>
<b>3.0 CONTROL THEORY .....</b>	<b>10</b>
<b>3.1 MODEL PREDICTIVE CONTROL.....</b>	<b>10</b>
<b>3.1.1 Model Predictive Control strategy:.....</b>	<b>10</b>
<b>3.1.2 Model Predictive Control structure:.....</b>	<b>12</b>
<b>3.1.3 Model Predictive Control elements.....</b>	<b>13</b>
<b>3.2 PROPORTIONAL-INTEGRAL-DERIVATIVE CONTROL.....</b>	<b>17</b>
<b>3.2.1 PID Control structure .....</b>	<b>17</b>
<b>3.2.2 PID Control parameters .....</b>	<b>18</b>
<b>3.2.3 Tuning of PID Control parameters.....</b>	<b>19</b>
<b>4.0 SIMULATION RESULTS .....</b>	<b>21</b>
<b>4.1 MODEL VALIDATION .....</b>	<b>22</b>
<b>4.2 INCREASE THE LEVEL FROM ZERO TO FIVE INCHES .....</b>	<b>23</b>

4.2.1	Parameters of the control strategies .....	26
4.2.2	The settling time analysis .....	27
4.2.3	The steady state error analysis .....	28
4.2.4	Summary .....	29
4.3	<b>INCREASE THE LEVEL FROM FIVE TO TEN INCHES</b> .....	30
4.3.1	The settling time analysis .....	32
4.3.2	The steady state error analysis .....	33
4.3.3	Summary .....	34
4.4	<b>INCREASE THE LEVEL FROM ZERO TO EIGHT INCHES THEN DECREASE TO FOUR INCHES</b> .....	35
4.4.1	Parameters of the control strategies .....	38
4.4.2	The overshoot and settling time analysis .....	38
4.4.3	The steady state error analysis .....	41
4.4.4	Summary .....	43
4.5	<b>EVALUATION OF THE EXPERIMENT</b> .....	44
5.0	<b>CONCLUSION</b> .....	46
	<b>BIBLIOGRAPHY</b> .....	48

## LIST OF TABLES

Table 1. Description of parameters and their corresponding value .....	7
Table 2. Effects caused by increasing the PID control parameter individually .....	19
Table 3. Ziegler-Nichols method .....	20

## LIST OF FIGURES

Figure 1. Model Predictive Control Strategy .....	11
Figure 2. Structure of Model Predictive Control .....	13
Figure 3. Structure of PID Control .....	17
Figure 4. Model validation.....	22
Figure 5. MPC and PID control result (0-5 inches, $t=0.2s$ , delay=0) .....	23
Figure 6. MPC and PID control result (0-5 inches, $t=0.2s$ , delay=5s).....	25
Figure 7. MPC and PID control results (0-5 inches, $t=0.2s$ , delay=10s) .....	25
Figure 8. MPC and PID control results (0-5 inches, $t=0.2s$ , delay=15s) .....	26
Figure 9. The settling time of the controllers for different delays .....	28
Figure 10. The steady state error of the controllers for different delays.....	29
Figure 11. MPC and PID control result (5-10 inches, $t=0.2s$ , no delay) .....	30
Figure 12. MPC and PID control result (5-10 inches, $t=0.2s$ , delay=5s).....	31
Figure 13. MPC and PID control result (5-10 inches, $t=0.2s$ , delay=10s).....	31
Figure 14. MPC and PID control result (5-10 inches, $t=0.2s$ , delay=15s).....	32
Figure 15. The settling time of the controllers for different delays .....	33
Figure 16. The steady state error of the controllers for different delays.....	34
Figure 17. MPC and PID control result (0-8-4 inches, $t=0.2s$ , no delay) .....	36
Figure 18. MPC and PID control result (0-8-4 inches, $t=0.2s$ , delay=5s) .....	36



Figure 19. MPC and PID control result (0-8-4 inches, $t=0.2s$ , delay=10s) .....	37
Figure 20. MPC and PID control result (0-8-4 inches, $t=0.2s$ , delay=15s) .....	37
Figure 21. The increasing settling time of the controllers for different delays.....	39
Figure 22. The decreasing undershoot of the controllers for different delays .....	40
Figure 23. The decreasing settling time of the controllers for different delays .....	40
Figure 24. The steady state error of the controllers for different delays when increasing the water level.....	42
Figure 25. The steady state error of the controllers for different delays when decreasing the water level.....	42

## 1.0 INTRODUCTION

Due to the fast development of process industry, the requirements of higher product quality, better product function, and quicker adjustments to the market change have become much stronger, which lead to a demand of a very successful controller design strategy, both in theory and practice [1]. As a closed loop optimal control method based on the explicit use of a process model, model predictive control has proven to be a very effective controller design strategy over the last twenty years and has been widely used in process industry such as oil refining, chemical engineering and metallurgy.

PID control is another popular control method in industrial control systems. Unlike model predictive controller, PID controller directly compares the collected data value with a reference data value, and then uses this compared error value for the new input in order to minimize it and keep the system data value reach and stay at the set point [2]. The parameters of PID controllers used in the calculation must be tuned according to requirements of system performance.

The purpose of this work is to study the theory of model predictive control method, analyze and indentify the characteristics and the performance of model predictive controller compared with PID controller when being implemented in the water level control system.

## 1.1 BACKGROUND OF MODEL PREDICTIVE CONTROL

Model predictive control has been a widely used control concept for over 15 years especially in the process industry. However, it had been proposed long before its application and had been implemented long before a thorough understanding of its theoretical properties when it was available [3] - [9]. Starting in late 1970s, various articles of model predictive control had come out presenting it as an effective application in the process industry, especially the ones using the name of Model Predictive Heuristic Control [7] which was later known as Model Algorithmic Control, and those in [9] with Dynamic Matrix Control (DMC). The common ground of these algorithms is that they utilize a dynamic process model (impulse response in the first and step response in the second) to predict the effect of the future control actions by using the current state of the plant as the initial state; the optimization method yields an optimal control sequence and the first control in this sequence is applied to the plant. During the repeated process of optimization at each sampling period, the information is always updated. These kinds of formulations took advantage of the digital computers, which had increasing potential at the time. However, from the point of becoming a concept, the first material that published an MPC algorithm was mentioned in [5]. After that, Rafal and Stevens presented an MPC algorithm in [10] with quadratic cost, moving horizon, and linear constraints based on an experiment of controlling a distillation column. For this experiment, they used a first-principles nonlinear model that they linearized at each time step.

During 1980s, academic interest in MPC started growing, particularly after some vital academic investigations [11] and two workshops were organized [12]. The idea of cost function and optimization has been presented, which made the application of optimal

control theory in MPC. According to the different forms of cost functions, the model predictive controllers at this time can be divided into three types: Dynamic matrix control with linear programming techniques [13], Quadratic programming solution of dynamic matrix control (QDMC) [14] and infinite norm formulation of model predictive control problems [15]. The understanding of MPC properties has reached to a new level and has now built a framework that is both theoretical and practical.

From 1989 to the present, Generalized Predictive Control (GPC) [3] and Predictive Functional Control (PFC) [16] have become the representation of the third generation of model predictive controllers. Compared to the second generation of MPC, the third generation does a much better job in dealing with the process control systems with quick response and has been popularly used in the industry.

## 1.2 MOTIVATION

Nowadays effective control schemes could largely influence the efficiency and quality of production in process industry; both practitioners and theoreticians have built strong interests on the industrial application of control theory since it experienced a history of bloom. Richalet [7-8] classified the controllers for the control problems into four hierarchical levels. The first level controllers are for the control problems dealing with some ancillary systems, in which PID controller could be a very good choice; the second level controllers are for the problems happened in multivariable dynamic process, which is interfered by some unmeasured perturbations. The third level controllers are for the optimization problems based on minimization of cost functions; MPC is also in this level. The fourth level controllers consists those time and space scheduling production problems that include the feasible research and have the best economical benefits. Because of the simple structure, low cost, convenient manipulation and the satisfaction for most of the production control, PID has become the major controller used in the family of level one. However, the economic benefits induced by level one and two are usually negligible, whereas the optimization concept in level three such as MPC can bring many improvements in the economics of the systems, can easily deal with multivariable case and also can be used to control a large number of processes with different kinds of dynamics and delays.

Unstable systems pose a greater challenge for the controllers; our study is focused on the water level control, which is an unstable system. For a better comparison of PID and MPC, we also included different time delays to test the robustness of the two control strategies.

## 2.0 EXPERIMENT DESCRIPTION

In order to observe the control effects of MPC and PID method, an experiment based on a water tank system was conducted in this study. Real-time simulation in Matlab was used for controlling the system process and comparing the control performance. Artificial delays were introduced into the simulation to compare the robustness of the two control methods.

### 2.1 WATER TANK SYSTEM

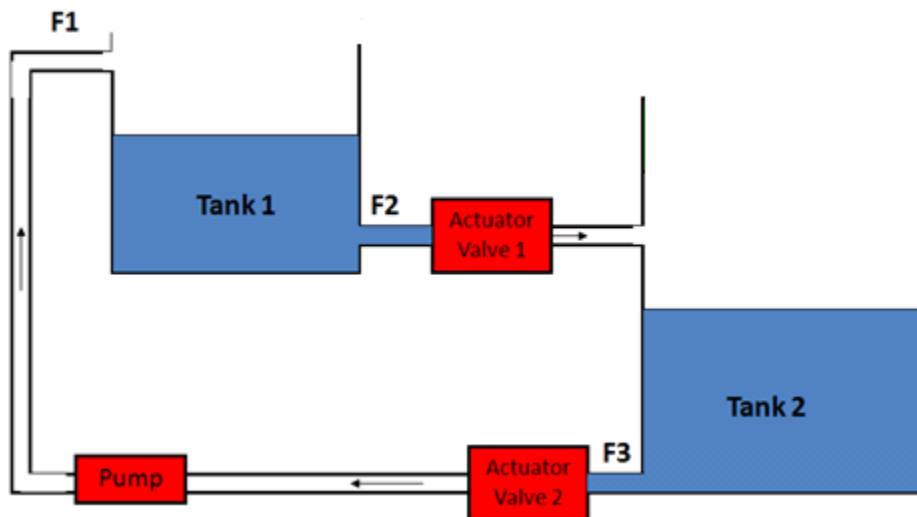

Figure 1. Wireless water tank system

The water tank system contains an ensemble of two custom designed acrylic tanks which are connected with each other with plastic tubes (Figure 1). The purpose of the system control is to enable the change of the water level in tank marked as tank 2 in Figure 1. This goal is achieved with help of two proportioning actuator valves and a pump. The levels of the water in both tanks are monitored by a ruler which is put inside each tank. For this thesis one actuator valve (valve 2 in Figure 1) is kept always open to allow the pump to control the drain of the water from tank 2. A short description of the functionality of the control station follows.

If an increase of the water level in tank 2 is desired, valve 1 is opened in order to let the water flow from tank 1 to tank 2. The flow is not only controlled by the proportioning valve, but also by the gravity force. During this time valve 2 is always fully opened and the pump is turned off. If a decrease of the water level in tank 2 is desired, valve 1 will be fully closed (valve 2 remains fully open) while the pump will be turned on and drain water from tank 2. The amount of water drained from tank 2 will be pumped into tank 1. Two automatic control algorithms which include Proportional-Integral-Derivative (PID) control and Model Predictive Control (MPC) are selected to directly control the water level in tank 2 to the desired value.

In order to test the control effect of Model Predictive Controller and PID controller, we used the closed loop system including two tanks, two actuator valves and one pump. We formed the system as a MIMO system by setting the control inputs as the status of the actuator valves and pump and the outputs as the water levels in two tanks; we also used water as the working fluid.

## 2.2 MATHEMATICAL MODEL OF WATER TANK SYSTEM

The mathematical description of the water tank system is required for the successful implementation of the automatic control algorithms. Moreover, the MPC controller uses an internal linear model of the plant to generate the control signal.

The description of the parameters used in modeling the water tank system and their assigned values are provided in Table 1. The dynamics of the water tank system are described by an ordinary differential equation:

$$A_2 \dot{H}_2 = F_2 - F_1 \quad (1)$$

The time derivative of the water level is proportional to the difference of the flow rate into and out of the tank. The equation (1) is given for tank 2. Hence, the flow rate out of tank is  $F_1$ , and the flow rate into tank is  $F_2$ :

**Table 1.** Description of parameters and their corresponding value

Parameter	Description	Value
$H_1$	Water level in tank 1	18''
$H_2$	Water level in tank 2	24''
$A_1$	Surface (bottom) area of tank 1	20''x20''
$A_2$	Surface (bottom) area of tank 2	10''x10''
$F_1$	Flow rate from tank 2 into tank 1	0.0044m/s <sup>2</sup> (pump on)
$F_2$	Flow rate from tank 1 into tank 2	0.0001063m/s <sup>2</sup> (valve fully open)
$K_p$	Pump output	0 (off) or 1 (on)
$K_1$	Status of the actuator valve 1	Between 0 (closed) and 1 (open)
$K_2$	Status of the actuator valve 2	1 (always open in this project)
$g$	Acceleration due to gravity	9.81m/s <sup>2</sup>
$R$	Radius of the tubing (tank 1 – tank 2, and tank 2 – pump)	1''
$R_p$	Radius of tubing (pump – tank 1)	¾''
$S$	Section of the tubing	0.00535m <sup>2</sup>
$P_x$	Dynamic pressure of x = pump/tank 1/tank 2	-
$\rho$	Water density	1000kg/m <sup>3</sup>
$E$	Elevation of tank 1	10''



$$F_1 = \sqrt{\frac{2P_{\text{pump}}}{\rho}} \pi R_p^2 \quad (2)$$

$$F_2 = \sqrt{\frac{2(P_{\text{tank1}} - P_{\text{tank2}})}{\rho}} \pi R^2 = \sqrt{\frac{2\rho g(H_1 + E - H_2)}{\rho}} \pi R^2 = \pi R^2 \sqrt{2g(H_1 + E - H_2)} \quad (3)$$

By substituting (2) and (3) into (1) we obtain:

$$\dot{H}_2 = \frac{\pi}{A_2} [R^2 \sqrt{2g(H_1 + E - H_2)} K_1 - R_p^2 \sqrt{\frac{2P_{\text{pump}}}{\rho}} K_p] \quad (4)$$

The corresponding dynamical equation (1) for tank 1 is the following:

$$A_1 \dot{H}_1 = F_1 - F_2 \quad (5)$$

Because the water tank system is a closed circuit system, the total volume of the water in the both tanks is constant. Therefore, the areas of the cross-section of both tanks are related as following:

$$\frac{A_2}{A_1} = \frac{1}{4} \quad (6)$$

By substituting (1) and (5) into (6) the relation of the level change in both tanks is obtained:

$$\dot{H}_1 = -\frac{\dot{H}_2}{4} \quad (7)$$

The water tank system is a multi-input multi-output (MIMO) system by setting the inputs as the status of the actuator valve 1 and pump, while the outputs are the water levels in the two tanks. The controlled variable is only the water level in tank 2. The equation

describing tank 1 is only included in the model for predicting the level in tank 1 for the purpose of estimating  $F_2$  which is dependent on  $H_1$ .

## **3.0 CONTROL THEORY**

The previous chapter introduced the structure of the water tank system and the mathematical description. In this chapter, we will show the two different control theories that we used to control the system. Step by step, we first explain the concept, and then build up the whole control system in Matlab simulation.

### **3.1 MODEL PREDICTIVE CONTROL**

The general design objective of model predictive control is to optimize, based on the computed trajectory of future manipulated variable  $u$ , predict the future behavior of the plant output  $y$ . The optimization is performed within a limited time window by giving plant information at the start of the time window.

#### **3.1.1 Model Predictive Control strategy:**

Model predictive control (MPC) includes a class of control algorithms that utilize an explicit process model to predict the future response of a plant [17]. At each control interval an MPC algorithm attempts to optimize future plant behavior by computing a sequence of future manipulated variable adjustments. The first input in the optimal

sequence is then sent into the plant, and the entire calculation is repeated at subsequent control intervals.

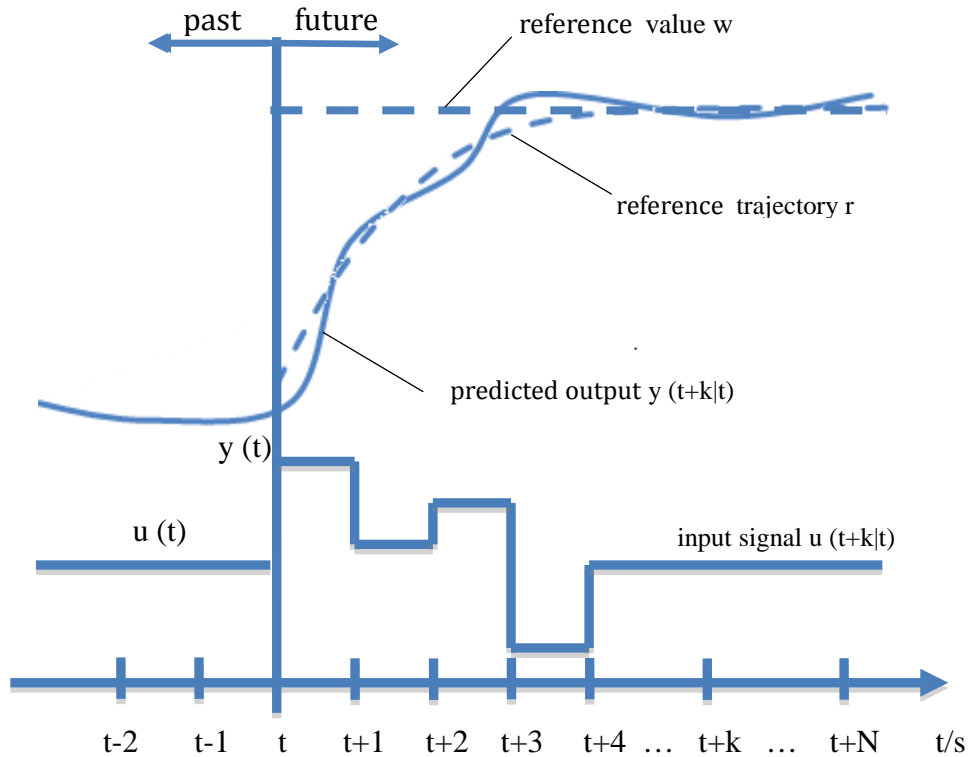

**Figure 1.** Model Predictive Control Strategy

Above is a figure shows the basic idea of predictive control based on a single-input, single output plant. We marked the current time as  $t$ , with the plant output  $y(t)$ . The figure also shows reference value  $w$ , reference trajectory  $r$  and control signal  $u(t+k|t)$ . The period from  $t$  to  $t+N$  is called the prediction horizon, which determines the predicted output  $y(t+k|t)$  and dictates how ‘far’ we wish the future to be predicted for.

The objective of model predictive control law is to drive future plant outputs  $y(t+k|t)$  as close as  $w$ , as shown in figure 1. This is done by using the procedure of receding horizon control concept at each sampling instant  $t$ , as discussed step by step below [3] [6]:

- 1) The future reference value (set point sequence) is set.
- 2) The process model is used to generate a set of predicted outputs  $y(t+k|t)$  for  $k=1\dots N$  over the prediction horizon. Compared to the reference value, the corresponding predicted system errors  $e(t+k) = w-y(t+k|t)$  are informed and those outputs depend on the past inputs and outputs as well as the future control signals  $u(t+k|t)$  ( $k=0\dots N-1$ ) that are to be sent to the system and calculated.
- 3) In order to keep the process as close as possible to the reference value, we include the control effort of the system and the future errors between predicted output and reference trajectory in a quadratic function where the input signals are assumed to remain as a constant after a control horizon. By minimizing the quadratic function which is also called cost function, we get a sequence of future input signals  $u(t+k|t)$  ( $k=0\dots N-1$ ).
- 4) Only the first element  $u(t)$  of the sequence is implemented into the plant while the rest of the control signals in the sequence are rejected because the output of the next sampling point is already known and the whole procedure is repeated at the next instant with the new value for a new prediction and control horizon. This concept is also called receding horizon control.

### **3.1.2 Model Predictive Control structure:**

In order to implement the receding horizon control concept into the plant, we drew the picture below showing the basic structure of MPC. From the picture, we can clearly see that during the whole control process, a process model is used in the MPC controller to

predict the future plant outputs based on the future inputs and initial values. Besides, the control effort and the future errors between predicted output and reference trajectory are taken into account in the optimizer with cost function and constraints in order to get optimized future inputs which are to be sent to the plant. Then the real output of the plant will be sent back to the process model as a current value to start the next prediction horizon.

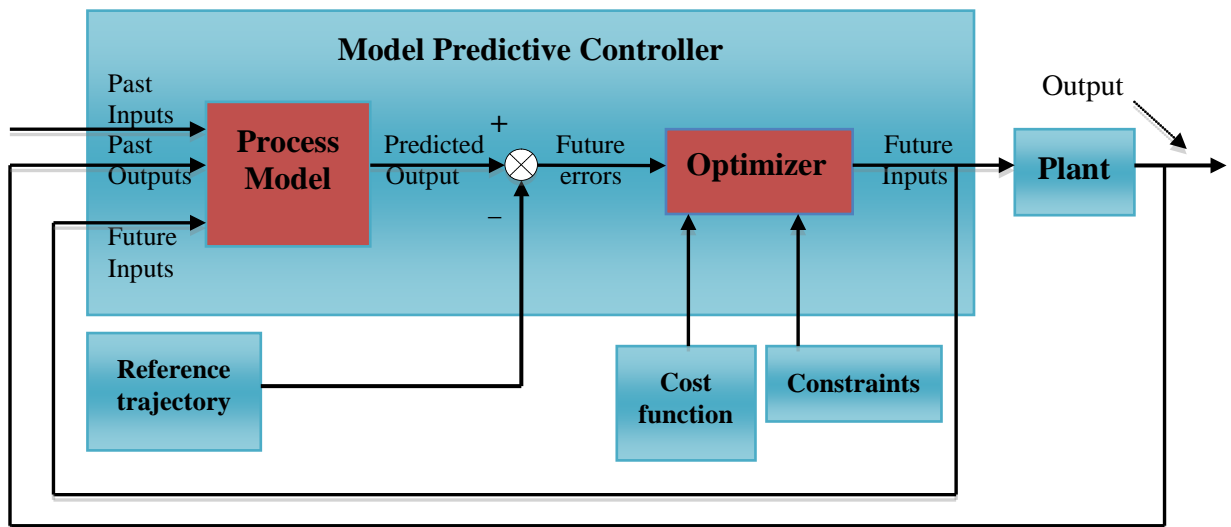

Figure 2. Structure of Model Predictive Control

### 3.1.3 Model Predictive Control elements

As discussed in [18], MPC algorithm includes a dynamic model of system process, the cost function and the history of old control signals to generate the optimal control moves.

From figure 2, we can see that the essence of MPC is to optimize the future behavior of the whole system process [19]. And the very future behavior is predicted through the process model that we choose, therefore, the process model is the element to capture the dynamic process and is the most significant element of an MPC controller.

In this thesis, we linearized the water tank system and used the linearized model as the process model to represent the original model inside the MPC controller, also in the form of state-space function. The linearization process is discussed below, the parameters  $P_{\text{pump}} = 498.867\text{kg}/(\text{ms}^2)$ ,  $F_1$  and  $F_2$  were estimated empirically after the water tank system was built.

Given the dynamic equation for water level in tank 2:

$$\dot{H}_2 = \frac{\pi}{A_2} [R^2 \sqrt{2g(H_1 + E - H_2)} K_1 - R_p^2 \sqrt{\frac{2P_{\text{pump}}}{\rho}} K_p]$$

By using the following notation  $G_1 = \dot{H}_1 = -\frac{H_2}{4}$  and  $G_2 = \dot{H}_2$ , the state-space mathematical model is obtained:

$$A = \begin{pmatrix} \frac{\partial G_1}{\partial H_1} & \frac{\partial G_1}{\partial H_2} \\ \frac{\partial G_2}{\partial H_1} & \frac{\partial G_2}{\partial H_2} \end{pmatrix} \Rightarrow \begin{pmatrix} -\frac{\pi R^2 g}{4A_2 \sqrt{2g(H_{10} + E - H_{20})}} K_{10} & \frac{\pi R^2 g}{4A_2 \sqrt{2g(H_{10} + E - H_{20})}} K_{10} \\ \frac{\pi R^2 g}{A_2 \sqrt{2g(H_{10} + E - H_{20})}} K_{10} & -\frac{\pi R^2 g}{A_2 \sqrt{2g(H_{10} + E - H_{20})}} K_{10} \end{pmatrix}$$

Let  $\alpha = \frac{\pi R^2 g}{A_2 \sqrt{2g(H_{10} + E - H_{20})}} K_{10}$  and the matrix A becomes:

$$A = \begin{pmatrix} -\frac{\alpha}{4} & \frac{\alpha}{4} \\ \alpha & -\alpha \end{pmatrix}$$

The matrix B is:

$$B = \begin{pmatrix} \frac{\partial G_1}{\partial K_1} & \frac{\partial G_1}{\partial K_p} \\ \frac{\partial G_2}{\partial K_1} & \frac{\partial G_2}{\partial K_p} \end{pmatrix} \Rightarrow \begin{pmatrix} -\frac{\pi R^2}{4A_2} \sqrt{2g(H_{10} + E - H_{20})} & \frac{\pi R_p^2}{4A_2} \sqrt{\frac{2P_{\text{pump}}}{\rho}} \\ \frac{\pi R^2}{A_2} \sqrt{2g(H_{10} + E - H_{20})} & -\frac{\pi R_p^2}{A_2} \sqrt{\frac{2P_{\text{pump}}}{\rho}} \end{pmatrix}$$

Let  $\beta = \frac{\pi R^2}{A_2} \sqrt{2g(H_{10} + E - H_{20})}$  and  $\gamma = \frac{\pi R_p^2}{A_2} \sqrt{\frac{2P_{\text{pump}}}{\rho}}$  to simplify the matrix B

to:

$$B = \begin{pmatrix} -\frac{\beta}{4} & \frac{\gamma}{4} \\ -\beta & -\gamma \end{pmatrix}$$

The matrix is  $C = [0 \ 1]$  (i.e. the output of the system is the level of tank 2), and the matrix  $D = 0$ . Hence the linear system is obtained:

$$x(t+1) = Ax(t) + Bu(t) = \begin{pmatrix} -\frac{\alpha}{4} & \frac{\alpha}{4} \\ \alpha & -\alpha \end{pmatrix} \begin{pmatrix} H_1(t) \\ H_2(t) \end{pmatrix} + \begin{pmatrix} -\frac{\beta}{4} & \frac{\gamma}{4} \\ -\beta & -\gamma \end{pmatrix} \begin{pmatrix} K_1(t) \\ K_p(t) \end{pmatrix} \quad (8)$$

$$y(t) = Cx(t) = [0 \ 1] \begin{pmatrix} H_1(t) \\ H_2(t) \end{pmatrix}$$

Another important element in MPC is the optimizer, in which an open loop optimal control problem is solved for the current state of the plant over an infinite horizon. The cost function is given below:

$$J = \sum_{k=N_1}^{N_2} \varphi [w(t+k) - y(t+k|t)]^2 + \sum_{k=0}^{N_u} \mu_1 [\Delta u_1(t+k)]^2 + \sum_{k=0}^{N_u} \mu_2 [\Delta u_2(t+k)]^2 \quad (9)$$

- Parameters:  $N_1$  and  $N_2$  are the lower and upper prediction horizons while  $N_u$  is the control horizon;  $w(t+k)$  is the reference value,  $y(t+k|t)$  is the predicted output;  $\Delta u_1(t+k)$  and  $\Delta u_2(t+k)$  are the inputs difference between time  $t+k$  and time  $t+k-1$ , after each control horizon,  $\Delta u_1$  and  $\Delta u_2$  are both zero;  $\varphi$ ,  $\mu_1$  and  $\mu_2$  are weighting coefficients.
- Constraints: In this thesis, we used a proportional valve which has 20 steps from fully close to full open, a pump that can be either open or close and tanks with different sizes; therefore, the limitations of all the stuff that we used in our system are unavoidable and are all subject to constraints. We set :

$$0 = u_{\min} \leq u_1(t) \leq u_{\max} = 1 \quad \forall t$$

$$0 = u_{\min} \leq u_2(t) \leq u_{\max} = 1 \quad \forall t$$



$$0 = y_{\min} \leq y(t) \leq y_{\max} = 30 \times 0.0254 = 0.762 \quad \forall t$$

As discussed in the receding horizon control concept and the MPC structure above, the cost function is used for the optimizer to generate the future input signals  $u(t+k|t)$ , so the future system outputs are required, however, they are not available but can be predicted by the process model. According to Maciejowski's method [20], the predicted outputs of our system are showed below:

$$\mathbf{y}(t) = \begin{bmatrix} CA \\ CA^2 \\ \vdots \\ CA^{N_2} \end{bmatrix} \mathbf{x}(t) + \begin{bmatrix} CB \\ CA^2B \\ \vdots \\ \sum_{i=0}^{N_2-1} CA^iB \end{bmatrix} \mathbf{u}(t-1) + \begin{bmatrix} B & \dots & 0 \\ C(AB+B) & \dots & 0 \\ \vdots & \ddots & \vdots \\ \sum_{i=0}^{N_2-1} CA^iB & \dots & \sum_{i=0}^{N_2-N_u} CA^iB \end{bmatrix} \mathbf{u} \quad (9)$$

This can be expressed in vector form as:

$$\mathbf{y}(t) = \mathbf{\Psi}\mathbf{x}(t) + \mathbf{Y}\mathbf{u}(t-1) + \mathbf{\Theta}\mathbf{u} \quad (10)$$

Therefore, the control law is obtained below:

$$\mathbf{u} = (\mathbf{\Theta}^T\mathbf{\Theta} + \lambda\mathbf{I})^{-1}\mathbf{\Theta}^T(w - \mathbf{\Psi}\mathbf{x}(t) - \mathbf{Y}\mathbf{u}(t-1)) \quad (11)$$

The performance of the control algorithm can be adjusted by modifying the parameters  $N_2$ ,  $N_u$ ,  $\varphi$  and  $[\mu_1, \mu_2]$ . In terms of implementation, the prediction horizon and control horizon are not convenient to use as tuning/setup parameters because they are generally chosen long enough, which cause the future increment has no significant effect on control performance [21]. However, adjusting  $\varphi$  and  $[\mu_1, \mu_2]$  is easily implemented as penalty terms which individually denotes the moves of controller output and error factor of the system output error.

## 3.2 PROPORTIONAL-INTEGRAL-DERIVATIVE CONTROL

As the most widely used control strategy, Proportional-Integral-Derivative (PID) control has shown its big advantage in industry. In this thesis, for better observing different control effects based on our system, we made a comparison between MPC and PID control.

### 3.2.1 PID Control structure

The basic idea of PID control is to compare the system output with the set points, and minimize the error by tuning the three process control inputs [22]. The structure of PID controller is showed in Figure 3:

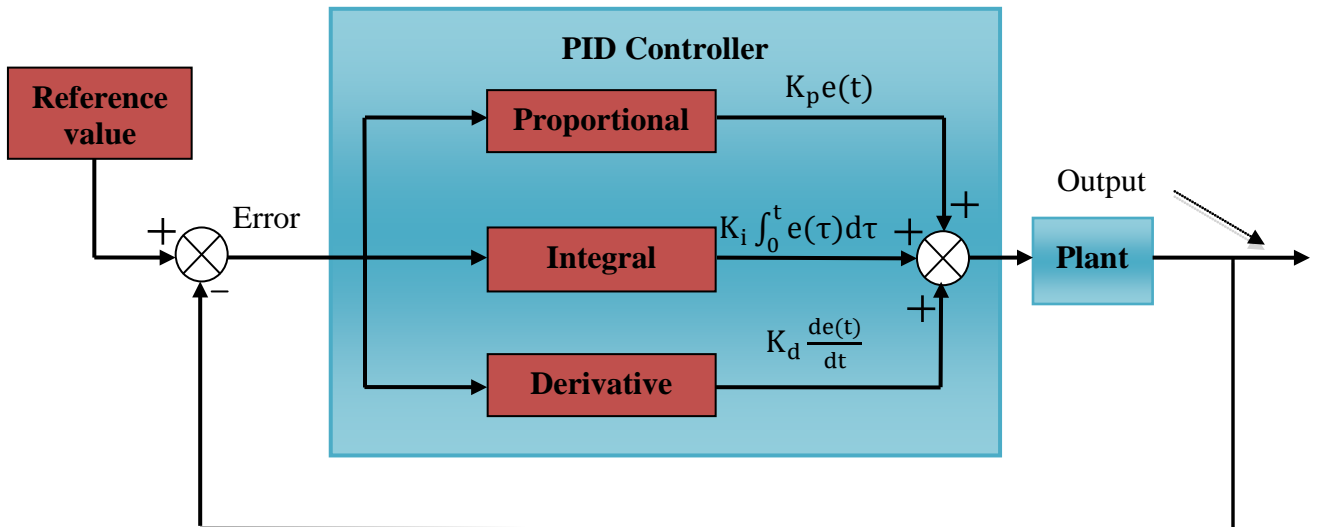

Figure 3. Structure of PID Control

As we can see from figure 3, in order to make the output value reach the reference value, the error between the two values is minimized by PID controller through adjusting the control input.

### 3.2.2 PID Control parameters

Proportional, Integral and Derivative terms are the three basic parameters of PID controller; these three terms fulfill the different requirements in the control process.

The implementation of proportional term is to make the reaction to the current error occurred in time, let the control effect take place as fast as possible and drive the error to the direction of minimization. Change this term will affect the steady state error and the dynamic performance.

The implementation of integral term is to eliminate the steady state error and accelerates the movement of the process reaching the reference value. Change this term will affect the steady state error and system stability.

The implementation of derivative term is to improve the system stability and the speed of dynamic reaction; it can also predict the future change of the error, so that an adjusted signal can be brought into the system before the error goes too large.

In order to calculate the output of the PID controller, the three terms are summed together, which can be expressed as formula (12):

$$u(t) = K_p e(t) + K_i \int_0^t e(\tau) d\tau + K_d \frac{de(t)}{dt} \quad (12)$$

### 3.2.3 Tuning of PID Control parameters

For the control process, better performance can be achieved by tuning the control loop, which is adjusting the control parameters to satisfy the desired control response. For PID controller, each of the three parameters has different effect on system control which is summarized in Table 1 from [23] based on the situation of increasing the parameter individually.

**Table 2.** Effects caused by increasing the PID control parameter individually

PID control parameters	Rise time	Overshoot	Settling time	Steady state error	stability
$K_p$	Decrease	Increase	Small Change	Decrease	Reduce
$K_i$	Decrease	Increase	Increase	Large Decrease	Reduce
$K_d$	Small Decrease	Decrease	Decrease	Small Change	Small Change

Therefore, tuning PID control parameters is a complicated process that we have to find an optimal way to arrange the values of the parameters for the control response. In this thesis, we used Ziegler-Nichols oscillation method, which is introduced by John G. Ziegler and Nathaniel B. Nichols in the 1940s [24].

The strategy of the method is that first set  $K_i$  and  $K_d$  to zero while  $K_p$  as a small gain, and then gradually increase the value of  $K_p$  until the value  $K_o$  that caused the oscillation of the control output, record the oscillation period  $P_o$ . Then we can adjust the parameters according to table 2.

**Table 3.** Ziegler-Nichols method

Type Control Parameters	P controller	PI controller	PID controller
$K_p$	$0.5K_o$	$0.45K_o$	$0.60K_o$
$K_i$		$\frac{1.2K_p}{P_o}$	$\frac{2K_p}{P_o}$
$K_d$			$\frac{K_p P_o}{8}$

## 4.0 SIMULATION RESULTS

The response of the control strategies (PID and MPC) used to operate the control valve and the pump are evaluated. The measurement of the reaction time (time interval between the instant when the change occurs and when the control system will generate a corresponding command signal), the settling time (the time required for the response curve to reach and stay within a range of 2% of the final value), and the other quality indicators are performed. Moreover, an investigation on the difference between the two control algorithms is shown.

For a better comparison of the two control methods (PID and MPC) based on the water tank system, three sets of control results were recorded based on the situations when the water level in tank 2 increased from 0 to 5 inches, from 5 to 10 inches, and increased from 0 to 8 inches then decreased by 4 inches. Two cases of water level increase were studied because the water flow from tank 1 into tank 2 is dependent on the difference in water level between the two tanks: as larger the difference in level between the two tanks, the larger the flow from tank 1 to tank 2. Besides, for each of the three cases, we included different time delays in order to observe and compare the robustness of different scenarios. The response of the valve and the pump should be prompt and efficient. The quality of a controller that operates the valve and the pump is characterized

by its ability to react fast to changes of the deviations from the reference water level, and to compensate these changes efficiently.

## 4.1 MODEL VALIDATION

As discussed in the previous chapter, for MPC control strategy, we linearized the system model and used the state space form to formulate the predictive control problem. Therefore, we need to do the review and validation for the process model in order to show the exactness of the identified model. As showed in Figure 4, the two models have the same validation plot with an acceptable error and a good process model match.

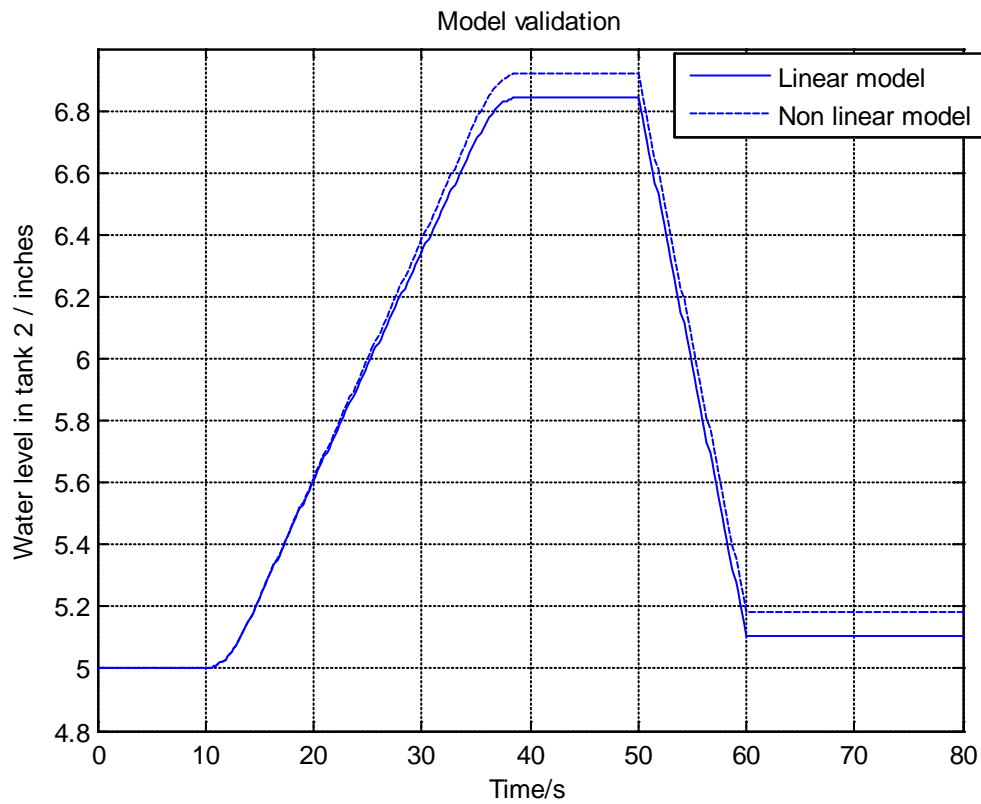
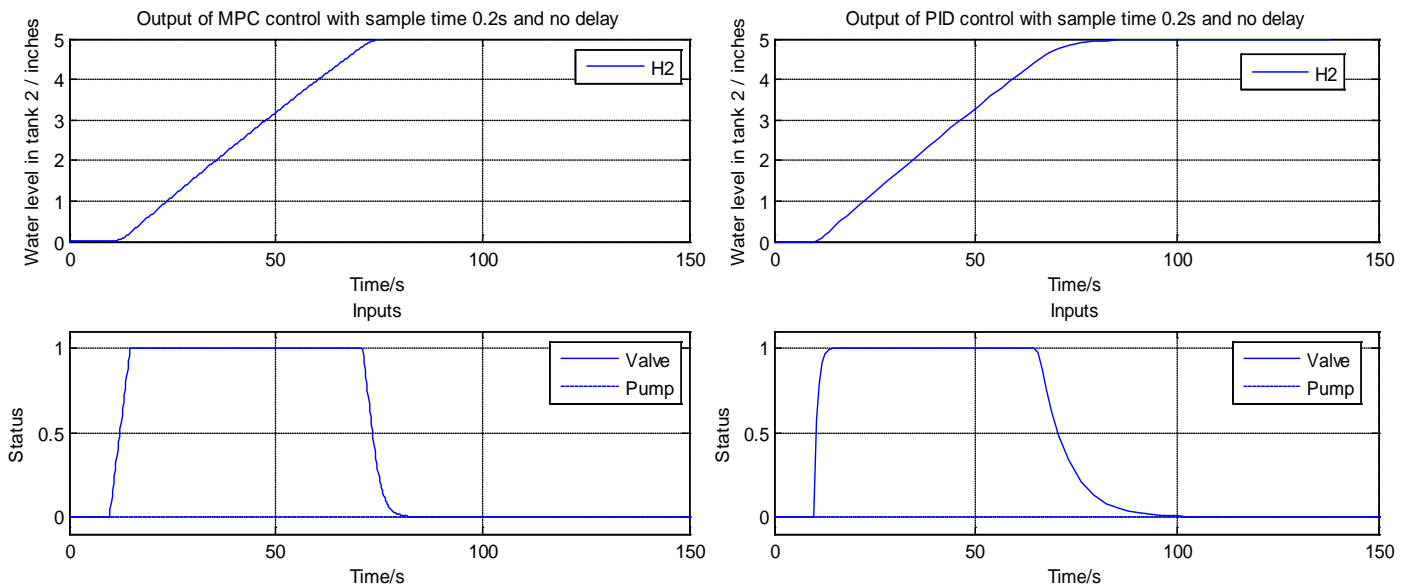

Figure 4. Model validation

## 4.2 INCREASE THE LEVEL FROM ZERO TO FIVE INCHES

Based on the situation of increasing the water level in tank 2 from 0 to 5 inches, the trajectory of the water level and the two statuses of the valve and the pump between two tanks are shown from Figure 5 to Figure 7 for comparison between MPC control strategy and PID control strategy with different time delays. The signal of the system was generated at the time of 10 seconds, so the first 10 seconds were not included in the analysis of the system performance. In order to perceive the change of the different control strategies as the time delay increased, the case of no time delay affected the system was shown first in Figure 5.



**Figure 5.** MPC and PID control result (0-5 inches,  $t=0.2s$ , delay=0)

In Figure 5, it can be observed that the valve opened at 10 seconds. This instant corresponds to the change of the reference value from 0 to 5 inches. The reaction time of the control algorithm is instantaneously in the sense that the control algorithm generates a



control signal right after the reference level is changed. Both results are expectable and after one sampling period, the first updated data of H2 was achieved.

About 4 sampling periods before water level in tank 2 reached 5 inches, the valve started to close proportionally causing the decrease of the flow rate from tank1 to tank2. By the time H2 reached the reference level, the valve was fully closed and the whole process was stopped. From the trajectory of inputs for both control methods, we can observe that during the whole control process, the valve opened and closed in order to let and stop the water flow into tank 2 while the pump stayed fully closed. This was because both control methods did not exhibit any overshoot during the process control that it was unnecessary for the pump to open.

In this case, the parameters of MPC controller were set as: Prediction horizon=10, control horizon=5, weighting coefficients  $\varphi = 1$ ,  $\mu_1 = 0.003$  and  $\mu_2 = 0.003$ . The three parameters of PID controller are individually set as:  $K_p=60$ ,  $K_i=0$  and  $K_d=0$ . The settling time for MPC was 62.4 seconds and for PID control was 66.263 seconds. Both controller exhibited good control effect in this situation.

As the amount of time delay increased, the performance of the water tank system was affected, and the change in both control strategies could be recognized. Figure 6, 7, 8 showed the trajectories of the water level and the two statuses of the valve and the pump between two tanks based on different control methods when time delay was set to 5s, 10s, and 15s, respectively.

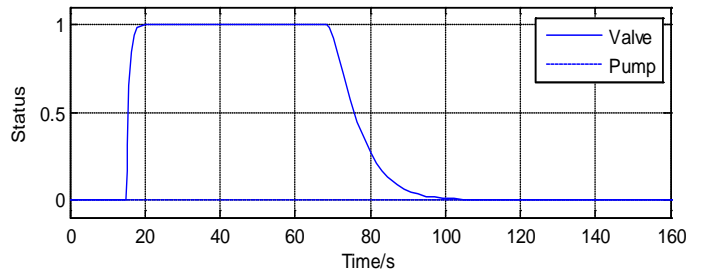
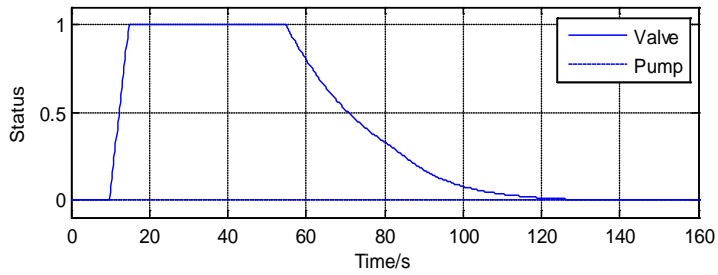
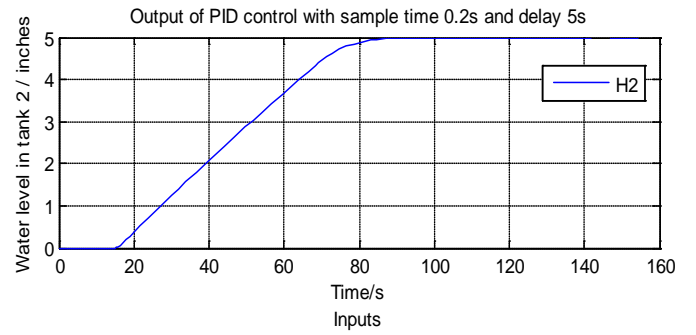
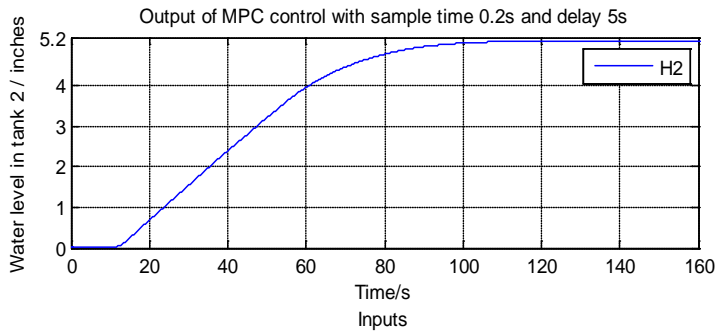

**Figure 6.** MPC and PID control result (0-5 inches,  $t=0.2s$ , delay=5s)

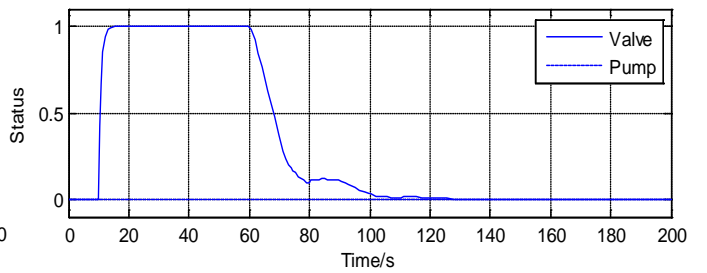
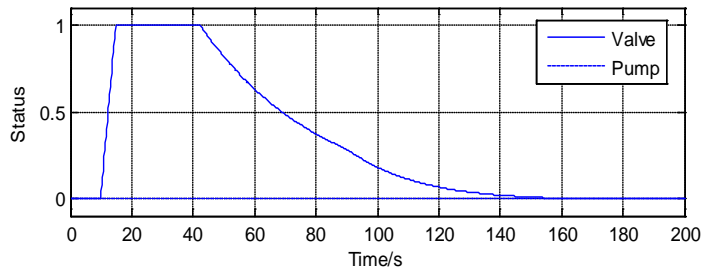
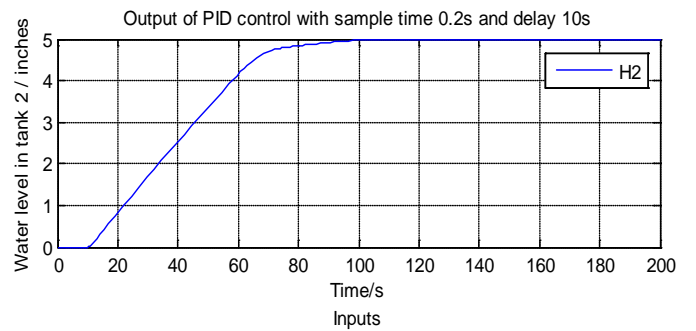
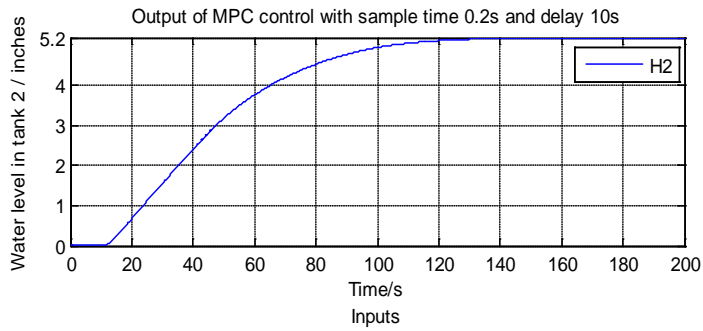

**Figure 7.** MPC and PID control results (0-5 inches,  $t=0.2s$ , delay=10s)

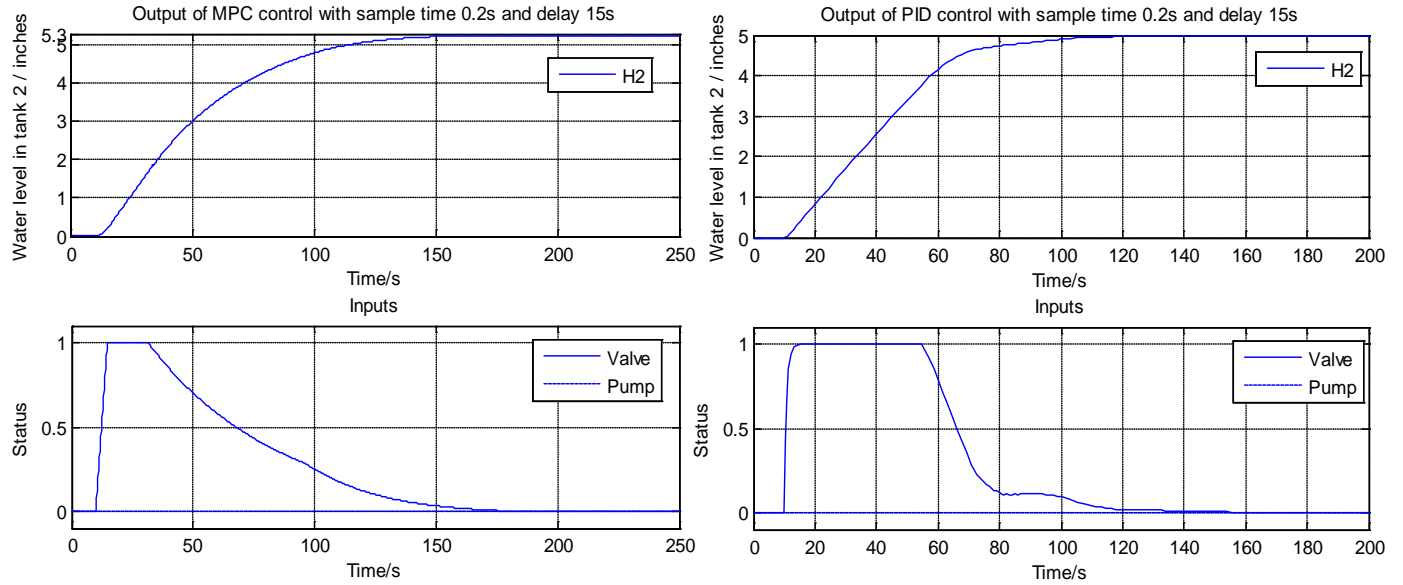

**Figure 8.** MPC and PID control results (0-5 inches,  $t=0.2s$ , delay=15s)

#### 4.2.1 Parameters of the control strategies

The parameters of both controllers for different time delays are set as:

In Figure 6, when time delay was set to 5s, the parameters of MPC controller were set as: prediction horizon=10, control horizon=5, weighting coefficients  $\varphi = 1$ ,  $\mu_1 = 0.01$  and  $\mu_2=0.01$  while for PID were set as:  $K_p=40$ ,  $K_i=0$  and  $K_d=30$ . The settling time for MPC was 75.4 seconds with steady state error 0.118, for PID control was 71.63 seconds.

In Figure 7, when time delay was set to 10s, the parameters of MPC controller were set as: prediction horizon=10, control horizon=5, weighting coefficients  $\varphi = 1$ ,  $\mu_1 = 0.013$  and  $\mu_2=0.013$  while for PID were set as:  $K_p=34.8$ ,  $K_i=0$  and  $K_d=217$ . The settling time for MPC was 86.4 seconds with steady state error 0.191, for PID control was 80.32 seconds.

In Figure 8, when time delay was set to 5s, the parameters of MPC controller were set as: prediction horizon=10, control horizon=5, weighting coefficients  $\varphi = 1$ ,  $\mu_1 = 0.015$  and  $\mu_2=0.015$  while for PID were set as:  $K_p=22.8$ ,  $K_i=0$  and  $K_d=199.5$ . The settling time for MPC was 95.4 seconds with steady state error 0.259, for PID control was 91.5 seconds.

#### **4.2.2 The settling time analysis**

As discussed in [25], time delay could affect the system performance such as the unsynchronization in the application, efficacy loss and instability. In this thesis, when the time delay was increased from 0s to 15s, the system performance changed accordingly. In order to make the output of the system satisfy our requirement, we adjusted the parameters of both controllers for different cases based on the tuning methods which were mentioned in the previous chapter. In the time delay cases, both control methods exhibited good control ability and robustness that there were no overshoots (the maximum peak value of the output response curve compared to the reference value of the system [26]) of the system output and the reaction time of the control algorithm is instantaneously in the sense that the control algorithm generates a control signal right after the reference level is changed.

However, compared to the case without any time delay, the settling time of the system became much longer, and keep increasing as the time delay increased. As shown in Figure 9, the settling time of MPC control method increased from 62.4 seconds to 95.4 seconds while for PID control method it increased from 66.263 seconds to 91.5 seconds. This explains the effect brought by the time delay to the system performance, but we

could not tell which controller is more advanced for this system since the differences between the settling times are small.

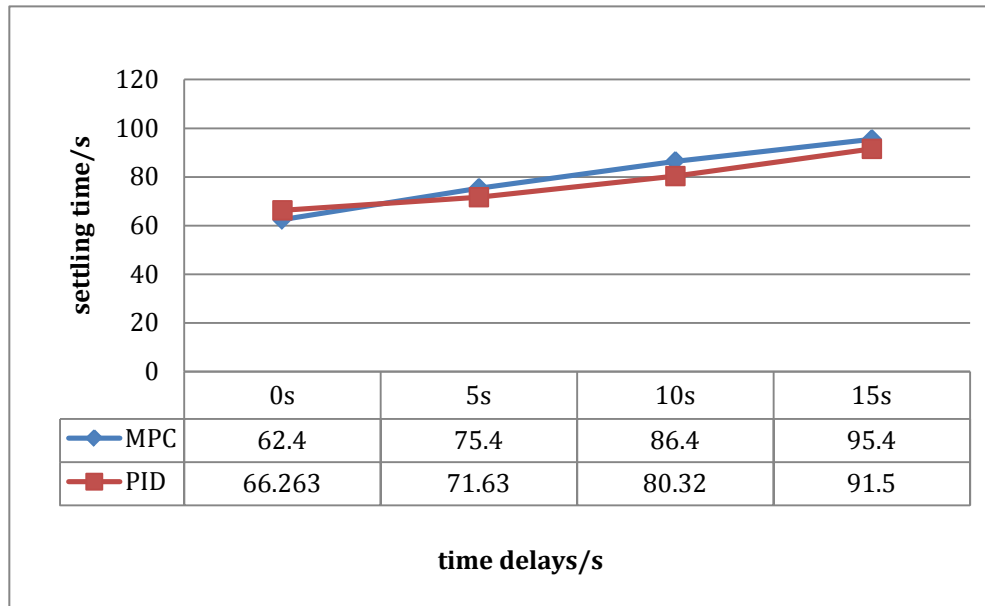
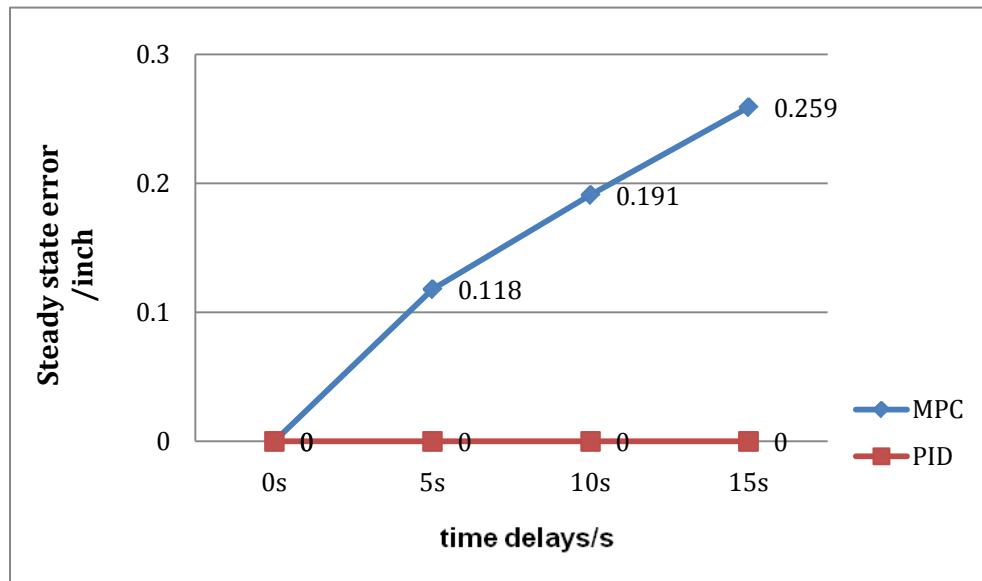

**Figure 9.** The settling time of the controllers for different delays

### 4.2.3 The steady state error analysis

The response curve of MPC control method started to have steady state error (the difference between the reference output and the actual one when the system reaches a steady state [27]) when the time delay was added to the system, as shown in Figure 10, it increased from 0 inch to 0.259 inches while PID control method showed no steady state error. This was because the non linear model that we generated from the dynamic system includes an integration part, which had an effect of eliminating the steady state error. When PID controller was directly applied to the non linear model during the process, the integration part of the model would automatically get rid of the steady state error for the system response no matter if there is a time delay, which was also the reason that we used

PD control instead of PID control. On the other side, MPC control strategy used a linear process model to approximate the non linear system model and to predict the future output; however, there was no integration part inside the linearized model to eliminate the steady state error as the time delay increased.



**Figure 10.** The steady state error of the controllers for different delays

#### 4.2.4 Summary

In this situation, when we increased the water level from 0 inch to 5 inches, both control methods made the output response reached the desired value within an acceptable time and there was no overshoot in any of the cases. However, PID control method showed a better control result which did not have any steady state error for the cases of different time delays while MPC did.

### 4.3 INCREASE THE LEVEL FROM FIVE TO TEN INCHES

In this section, we also conducted an experiment to observe the control effects when the water level in tank 2 was increased from 5 inches to 10 inches for the purpose of comparing the effects of different control strategies, different delays were also included in this situation. Moreover, the similarities and differences between the situation of increasing water level from 0 to 5 inches and the situation of increasing water level from 5 to 10 inches will be examined.

Same as the previous situation, the trajectory of the water level and the two statuses of the valve and the pump between two tanks are shown from Figure 11 to Figure 14 for comparison between MPC control strategy and PID control strategy with different time delays. Again, the first 10 seconds were not included in the analysis of the system performance. In order to perceive the change of the different control strategies as the time delay increased, the case of no time delay affected the system was shown first in Figure 10, followed by the cases with different time delays as 5s, 10s, and 15s.

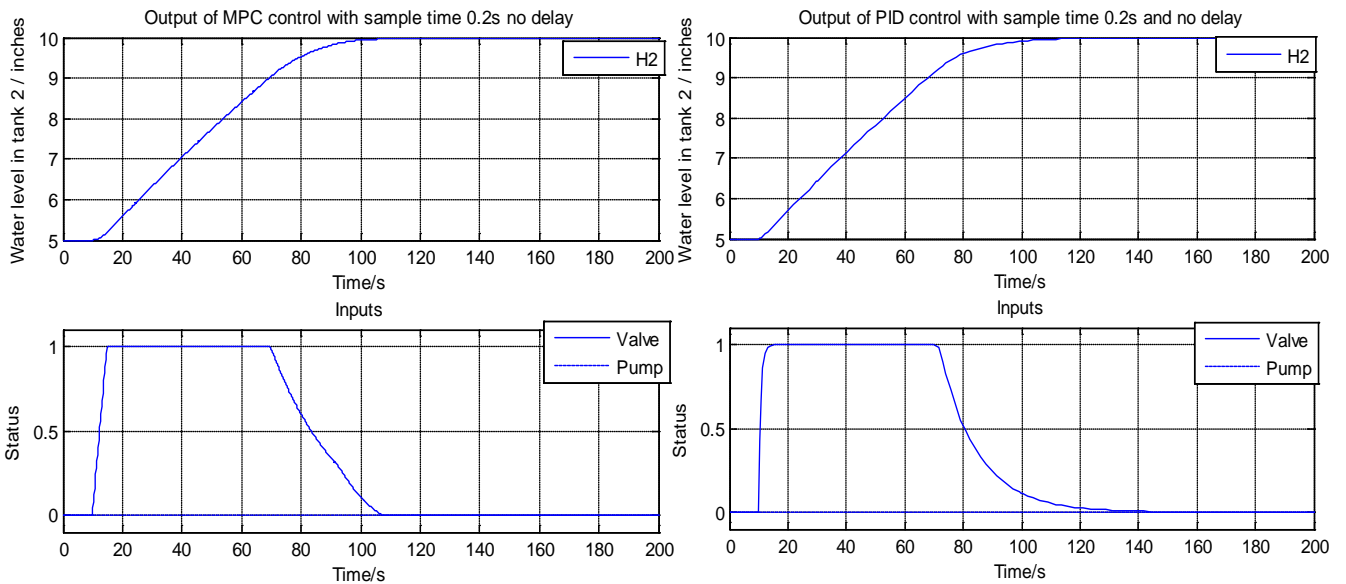
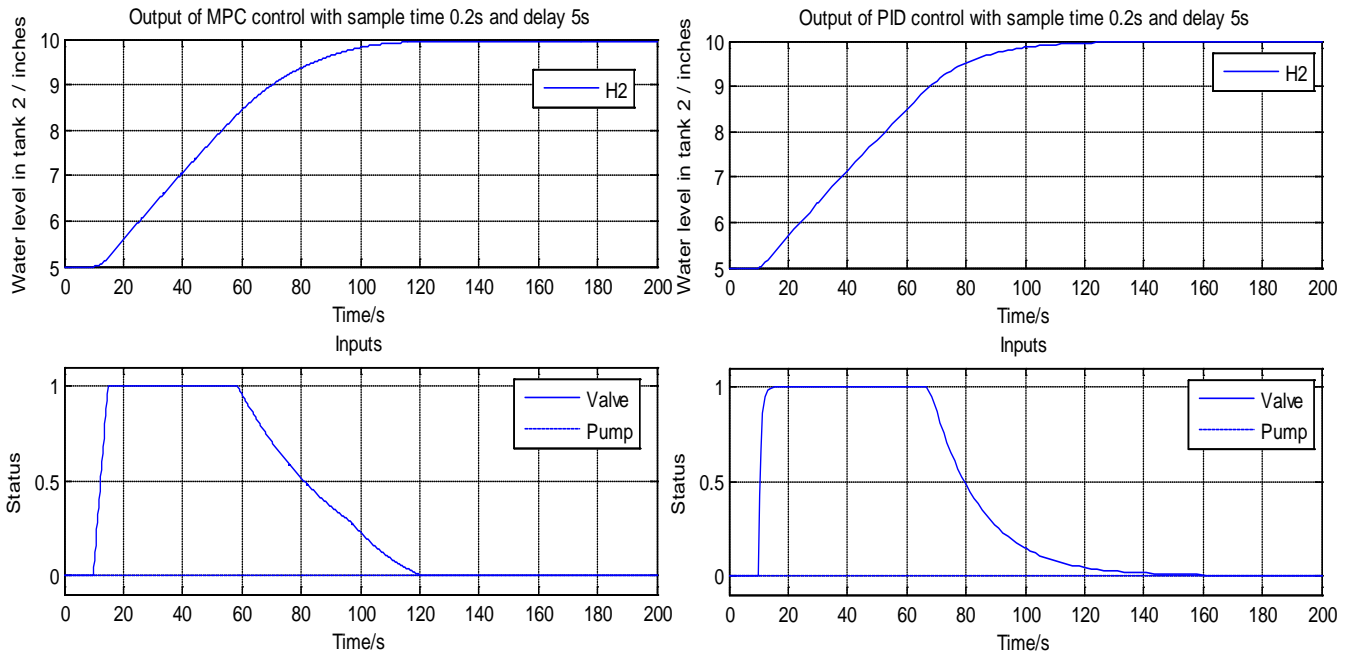
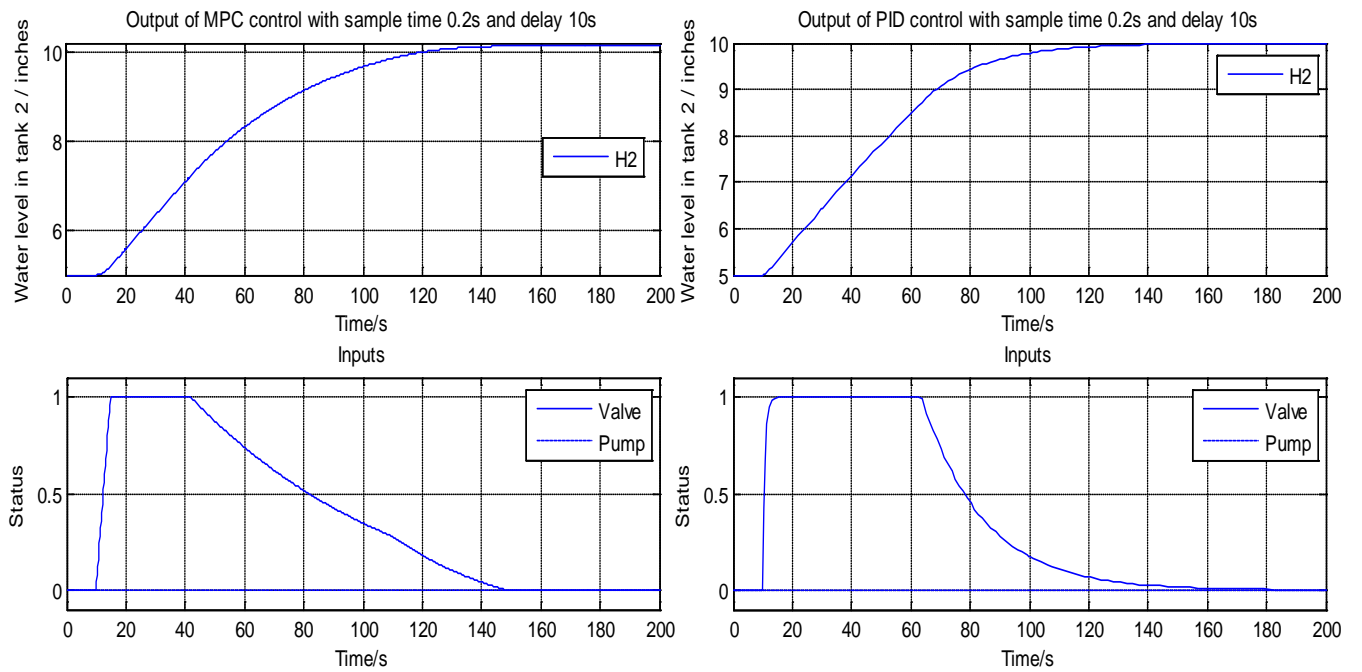

Figure 11. MPC and PID control result (5-10 inches,  $t=0.2s$ , no delay)

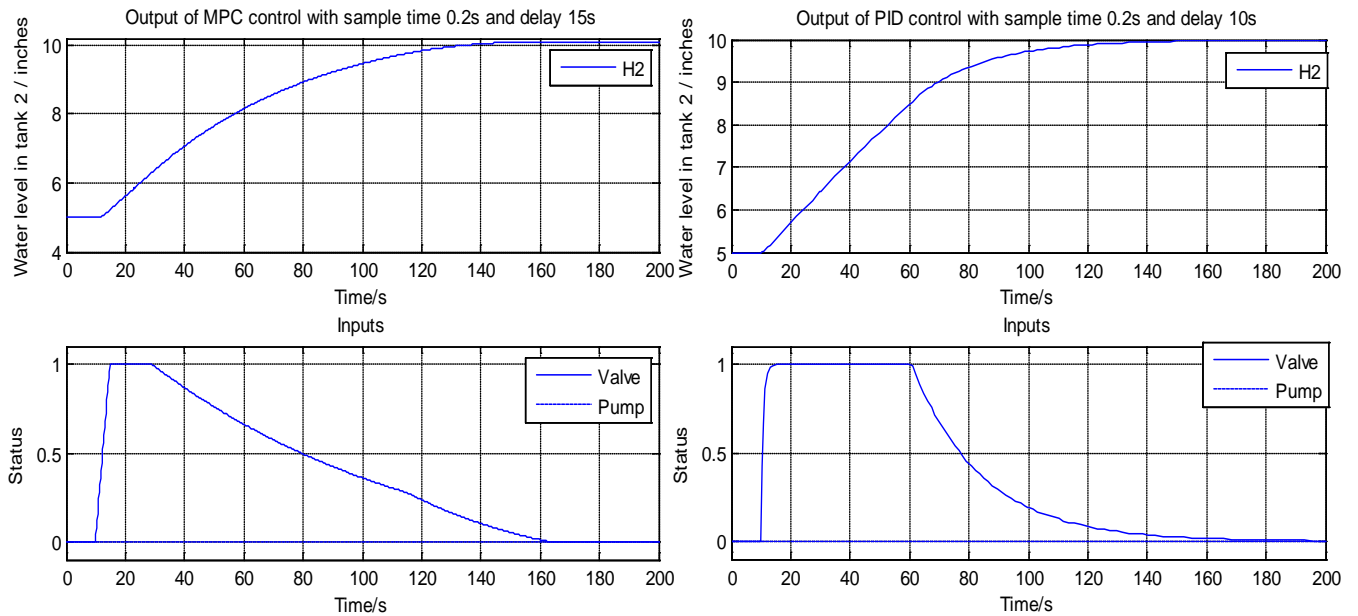

**Figure 12.** MPC and PID control result (5-10 inches,  $t=0.2s$ , delay=5s)



**Figure 13.** MPC and PID control result (5-10 inches,  $t=0.2s$ , delay=10s)



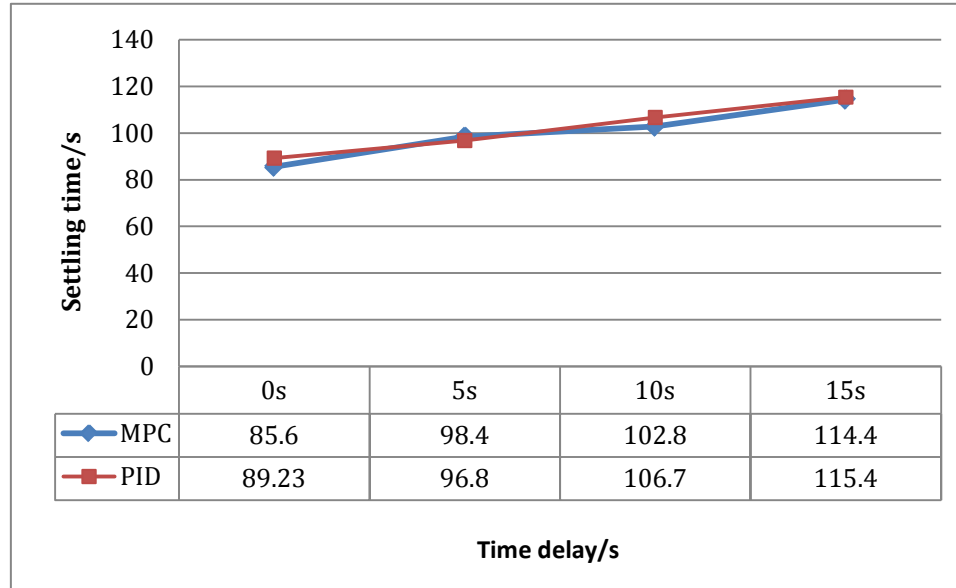

**Figure 14.** MPC and PID control result (5-10 inches,  $t=0.2s$ , delay=15s)

### 4.3.1 The settling time analysis

The settling time of the two controllers based on the four cases of this situation are shown in Figure 15, which indicates that the velocity of increasing water level from 5 inches to 10 inches is much slower than that of increasing water level from 0 to 5 inches.

As we can see from Figure 15, the settling times for both controllers were much larger than that in the cases of previous situation. For MPC, the settling time ranged from 85.6seconds to 144.4 seconds while for PID ranges from 89.23 seconds to 115.4 seconds. This result is expected because the initial water level in tank 2 increased by 5 inches as compared to the previous situation, and the level difference between the two tanks became smaller, then according to equation (3), the flow rate from tank 1 into tank 2 decreased. Subsequently, the time for the water in tank 2 to reach the reference level became much longer compared to the cases of previous situation.



**Figure 15.** The settling time of the controllers for different delays

### 4.3.2 The steady state error analysis

Similar to the previous situation, the response curve of MPC control method started to have steady state error for the cases that system included time as shown in Figure 16, it increased from 0 inch to 0.118 inches while PID control method showed no steady state error.

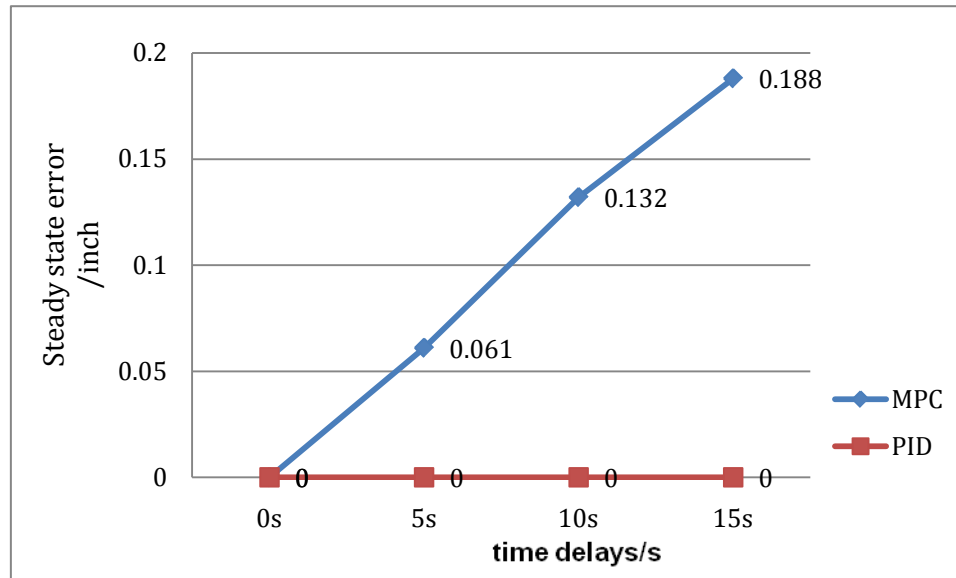

**Figure 16.** The steady state error of the controllers for different delays

### 4.3.3 Summary

To show the difference of the settling time between this situation and the previous one is the reason that we conducted this set of experiment. As a result, it proved that the control methods that we used for this system well satisfied the real physical situations.

For the performance of the control strategies, both made the output response reached the desired value within an acceptable time and there was no overshoot in any of the cases. Still, PID control method showed a better control result which did not have any steady state error for the cases of different time delays while MPC did.

#### **4.4 INCREASE THE LEVEL FROM ZERO TO EIGHT INCHES THEN DECREASE TO FOUR INCHES**

In order to better observe the control effects and compare the robustness of the two control strategies based on the dynamic process, we conducted another set of experiments that we increased the water level in tank 2 from 0 inch to 8 inches first, and then after it reached the reference level, we changed the reference water level to 4 inches. The trajectory of the water level and the two statuses of the valve and the pump between two tanks are shown from Figure 17 to Figure 20 for comparison between MPC control strategy and PID control strategy with different time delays. Again, the first 10 seconds were not included in the analysis of the system performance.

During the dynamic process, unlike the previous situations, the water was drained from Tank 2 to Tank 1 from 8 inches to 4 inches. The flow rate of the water out of Tank 2 was controlled by the pump and was a constant value as there was no gravity effect between the different levels and the pump can only operate in on/off mode. To be noticed is the flow rate generated by the pump was much higher than that generated by the valve using the difference in water level.

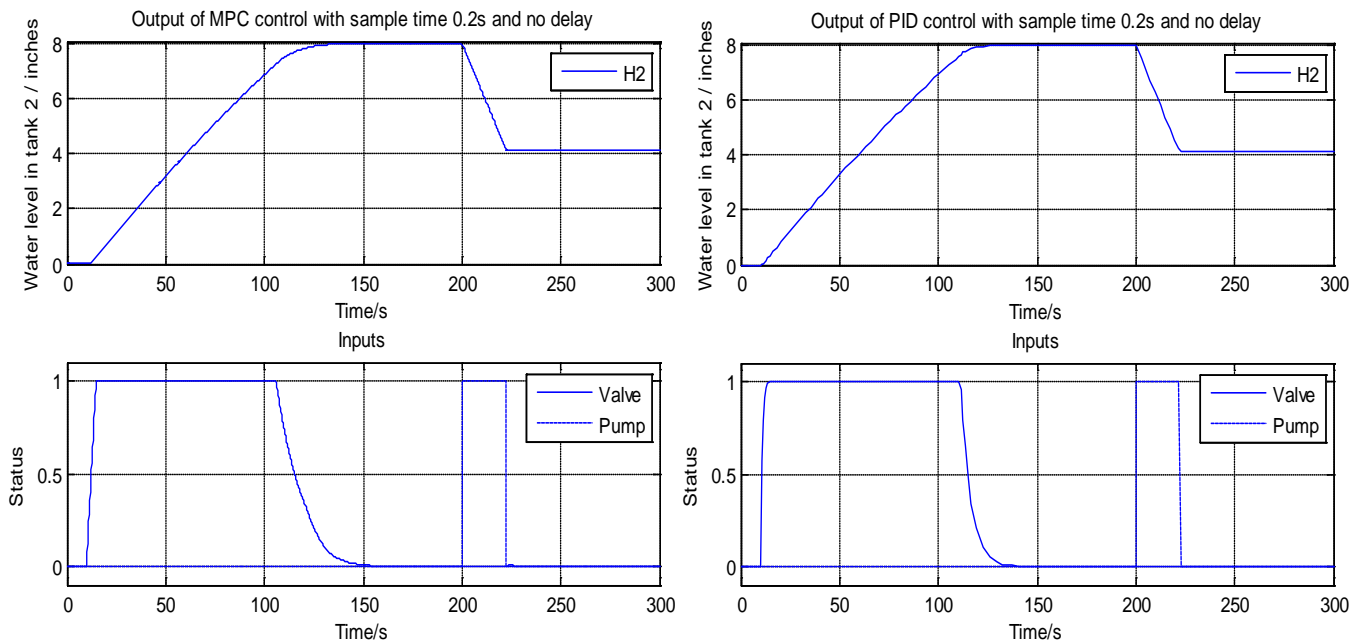

**Figure 17.** MPC and PID control result (0-8-4 inches,  $t=0.2s$ , no delay)

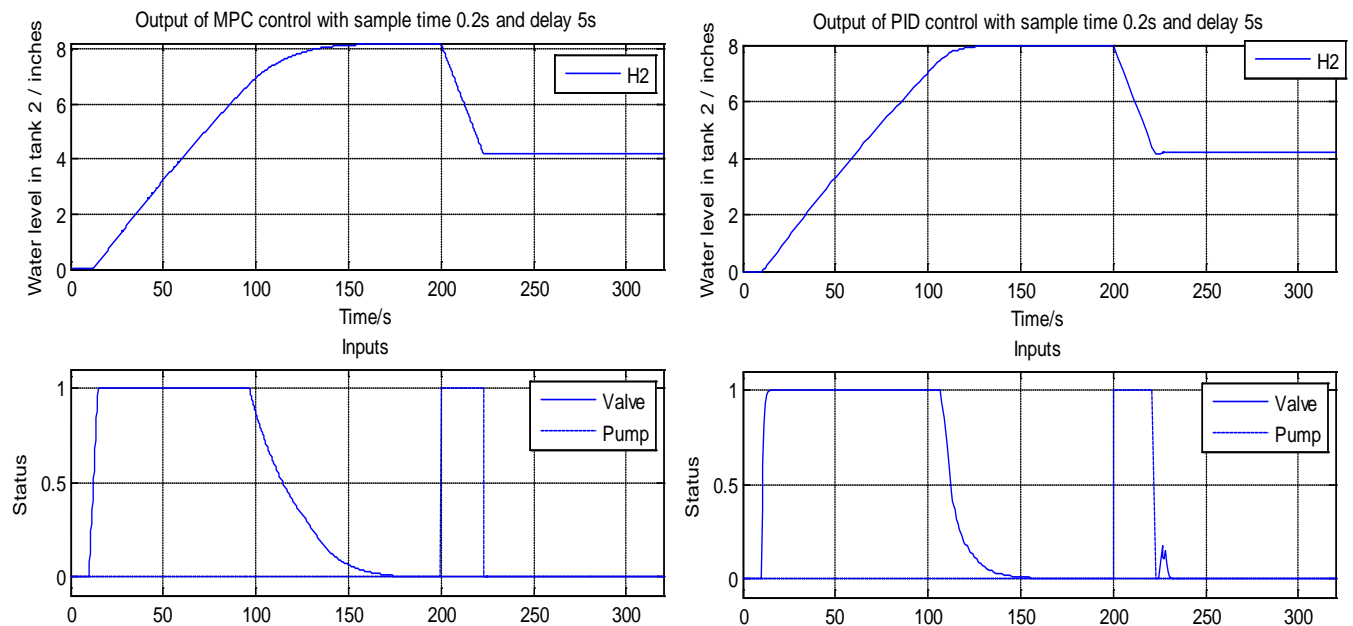

**Figure 18.** MPC and PID control result (0-8-4 inches,  $t=0.2s$ , delay=5s)

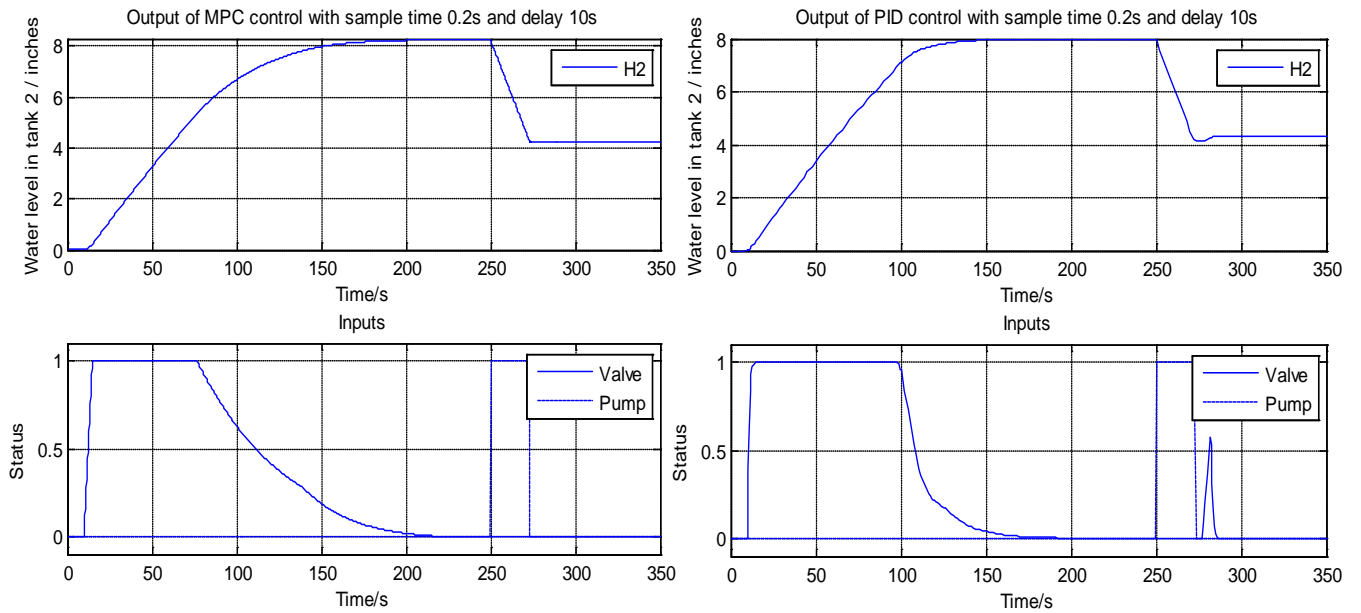

**Figure 19.** MPC and PID control result (0-8-4 inches,  $t=0.2s$ , delay=10s)

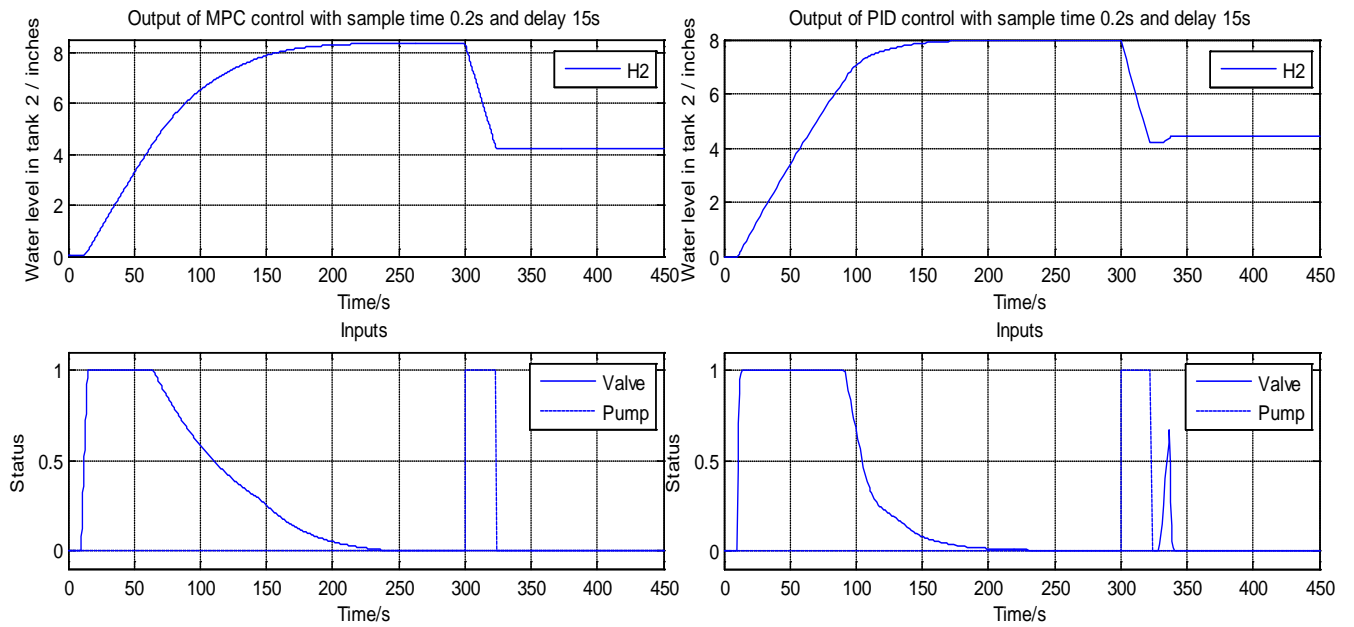

**Figure 20.** MPC and PID control result (0-8-4 inches,  $t=0.2s$ , delay=15s)

#### 4.4.1 Parameters of the control strategies

The parameters of both controllers for different time delays are set as:

In Figure 17, when there was no time delay, the parameters of MPC controller were set as: prediction horizon=10, control horizon=5, weighting coefficients  $\varphi = 1$ ,  $\mu_1 = 0.007$  and  $\mu_2=0.014$  while for PID were set as:  $K_p=110$ ,  $K_i=0$  and  $K_d=0$ .

In Figure 18, when time delay was set to 5s, the parameters of MPC controller were set as: prediction horizon=10, control horizon=5, weighting coefficients  $\varphi = 1$ ,  $\mu_1 = 0.01$  and  $\mu_2=0.0005$  while for PID were set as:  $K_p=58.2$ ,  $K_i=0$  and  $K_d=189.15$ .

In Figure 19, when time delay was set to 10s, the parameters of MPC controller were set as: prediction horizon=10, control horizon=5, weighting coefficients  $\varphi = 1$ ,  $\mu_1 = 0.014$  and  $\mu_2=0.0001$  while for PID were set as:  $K_p=31.2$ ,  $K_i=0$  and  $K_d=195$ .

In Figure 20, when time delay was set to 15s, the parameters of MPC controller were set as: prediction horizon=10, control horizon=5, weighting coefficients  $\varphi = 1$ ,  $\mu_1 = 0.016$  and  $\mu_2=0.0001$  while for PID were set as:  $K_p=20.7$ ,  $K_i=0$  and  $K_d=194.0625$ .

#### 4.4.2 The overshoot and settling time analysis

In this situation, we will divide the whole system process into increasing water level part and decreasing water level part in order to do the analysis separately. The increasing settling time of the two controllers based on the four cases of this situation are shown in Figure 21 while the decreasing one is shown in Figure 22.

As we can see from Figure 21, during the increasing processes of the water level based on the four cases of time delay, both control strategies had no undershoot and it took the two controllers almost the same period of time to control the water level in tank 2 reach the certain range of the reference level. For MPC, the settling time ranged from 113.8 seconds to 142 seconds while for PID ranged from 106.8 seconds to 147 seconds.

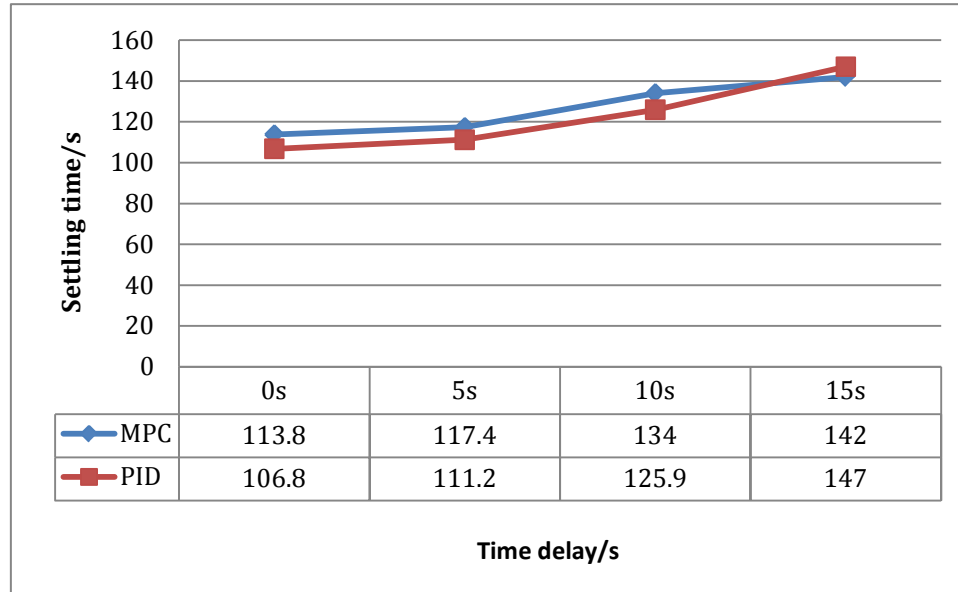
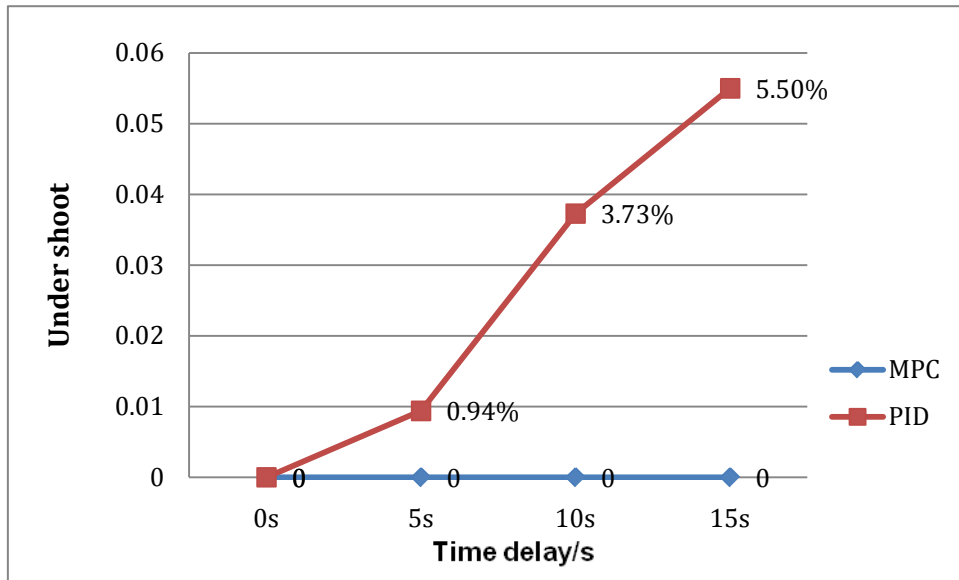

**Figure 21.** The increasing settling time of the controllers for different delays

For the decreasing process, to be noticed is that the PID control output response curve started to have undershoot as showed in Figure 22, which caused the valve between the two tanks opened again to let the water flow from tank 1 to tank 2 when the pump was closed. This compensation process largely increased the settling time, so as Figure 23 showed, the settling time of PID control method ranged from 22.7 seconds to 40.7 seconds while ranged from 22.4 to 23.6 seconds of MPC control method.

As a result, MPC controller took much less time than PID controller in controlling the pump to drain the water from tank 1 to tank2 in order to reach the lower reference water level without any undershoot.





**Figure 22.** The decreasing undershoot of the controllers for different delays

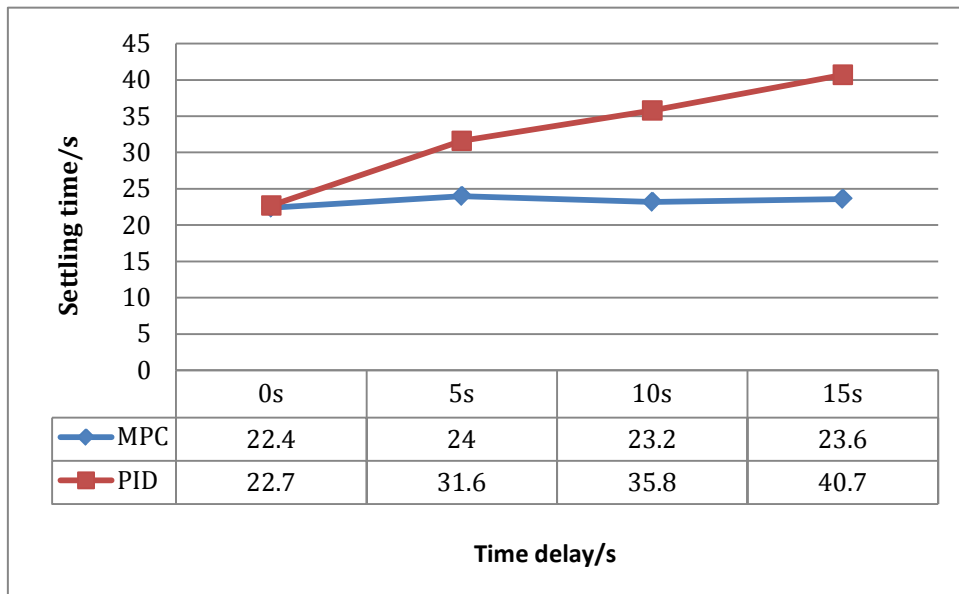

**Figure 23.** The decreasing settling time of the controllers for different delays

#### 4.4.3 The steady state error analysis

By using the same method of analyzing the overshoot and settling time of this situation, we also divided it into increasing water level process and decreasing water level process in order to study the steady state error for both controllers based on different time delays in these two processes.

In Figure 24, similar to the previous situations, during the process of increasing the water level, after the system reached a steady state, the response curve of MPC control method started to have steady state error, and increased from 0 inch to 0.337 inch as the time delay added to the system increased from 0s to 15s. On the other hand, the response curve of PID control method didn't have any over shoot during this process.

After we changed the reference level into a lower one, the system process was changed accordingly; the response curves of both controllers started to have steady state error and increasingly changed as the time delay increased. MPC has the range from 0.131 inch to 0.237 while PID has the range from 0.156 inch to 0.19 inch as shown in Figure 25.

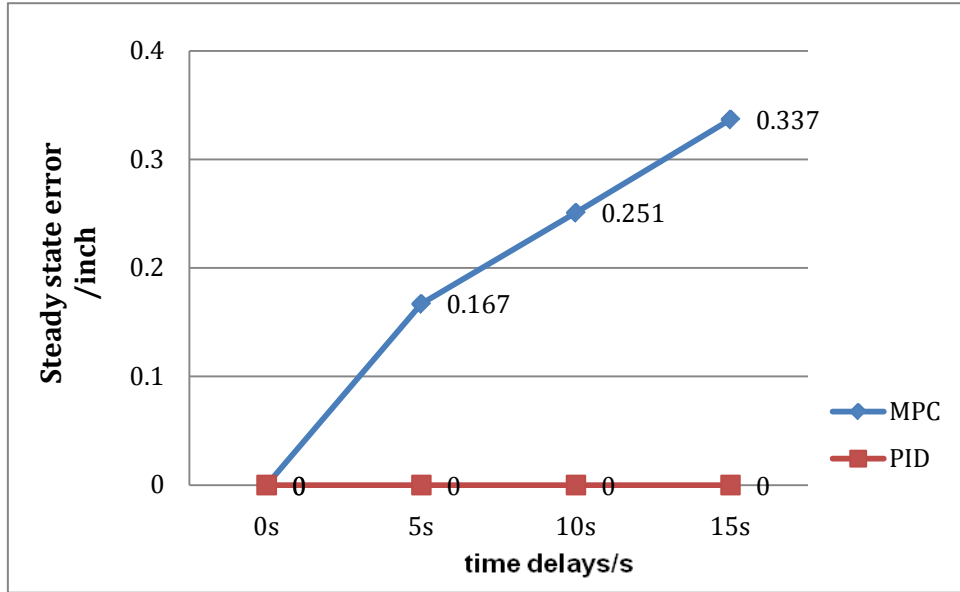

**Figure 24.** The steady state error of the controllers for different delays when increasing the water level

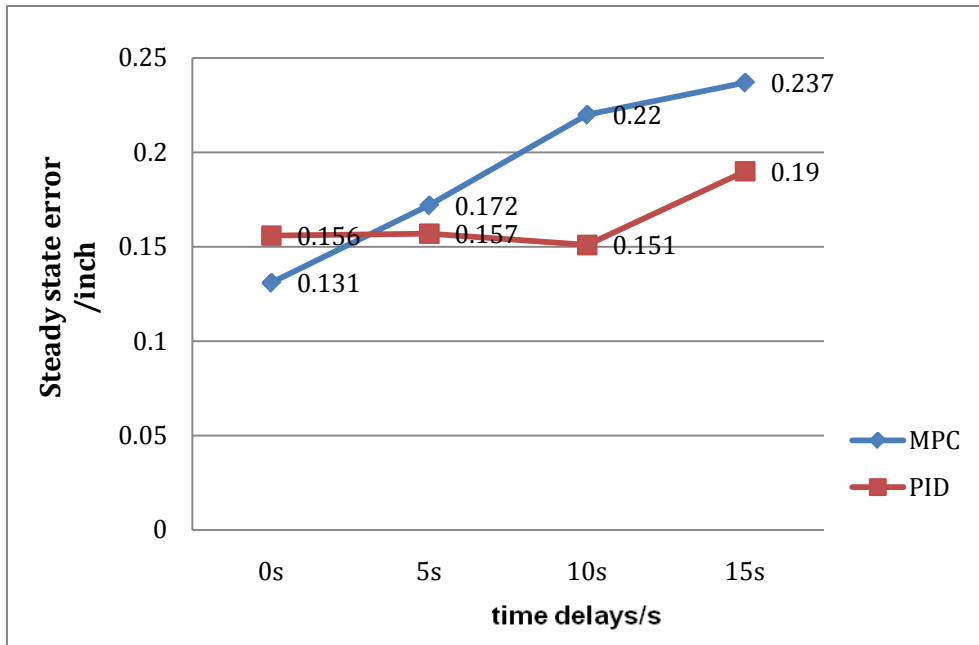

**Figure 25.** The steady state error of the controllers for different delays when decreasing the water level

#### 4.4.4 Summary

In this situation, we made a change of the reference level during the system process, during the increasing process, both control methods made the output response reached the desired value within an acceptable time and there was no overshoot in every case. Similar to the precious cases, MPC had steady state error while PID did not. However, during the decreasing process, MPC exhibited a good robustness of being able to withstand the changes in the process based on different time delays with a stable settling time, acceptable steady state error and no undershoot, PID control response started to have undershoot that largely affected the settling time of the system as well as the steady state error.

Therefore, MPC control method showed it advance in capturing the dynamic change during the system process over PID control method.

## 4.5 EVALUATION OF THE EXPERIMENT

In this experiment, MPC controller used an internal linear model of the water tank system as the process model to predict the future output and generate the control signals after performing the mentioned optimization algorithm. PID controller was applied to the original non-linear model of the water tank system.

From the comparison of the output response based on two control strategies, the control effects of both controllers were similar in terms of settling time and overshoot for the situations in which the water level in tank 2 was only increased to a reference level without any future change. However, regarding the accuracy of the output response, PID control method showed better results than MPC without having any steady state error. This was because the original non-linear model used by PID strategy included an integration part that eliminated the steady state error for the control response while the process model used by MPC strategy still had some mismatch compared to the original model

When the system dynamic was changed during the operation that the water in tank 2 was drained by the pump to reach the new reference level after reaching the old one, PID control method exhibited considerable undershoot which caused the valve to be opened subsequently after the pump was fully closed in order to compensate for the level difference. Moreover, the output response under PID control method started to have steady state error as the time delay increased after the system was undisturbed. On the other hand, MPC showed a good robustness towards the dynamic change and the time delay by not having any undershoot and having acceptable steady state error. This was because during the dynamic process, the system model was linearized along the reference

trajectory every 1 inch the water level changed, which was more accurate than a linearization only at one operation point and allowed the MPC controller to capture the dynamic properties better than PID.

This comparison between the MPC algorithm and PID yields the former more attractive because of the capability of prediction as it stored a linear internal model representation of the system to be controlled. Moreover, MPC is more robust to multiple changes in the system dynamics and the varying time delay. PID would need adjustment of its parameters for any of the changes during the system operation.

## 5.0 CONCLUSION

The analysis of the experiment performed in this thesis shows the application of the water level control in a two-tank closed loop system, whose performance is investigated for evaluating the quality of the control relative to the two proposed control algorithms, Proportional Integrate Derivative method and Model Predictive Control method.

A nonlinear model representing the water tank system was implemented for the two controllers in order to interpret the discrete control mechanism. The parameters of both controllers for different situations were adjusted such that the dynamic process of the system yielded the reference one.

Based on the comparison of the two control methods, the process model MPC used to represent the system enables MPC controller to predict the state of the plant during the dynamic operation, which is particularly attractive as compared with PID because the dynamics change as the water level changes in the tanks, and a corresponding linearized model of the water tank system can be used in real time by the MPC. However, the PID controller needs to have its parameters adjusted for “optimal” performance for every different case or when the dynamics of the system are altered by the level change. This may be inconvenient when the time delays or the plant dynamics change during operation.

To be noticed that the state space representation of the water tank system in (8) also has the dynamics of the water level in tank 1 included. This is mainly for the MPC to account for the level change in tank 1 in order to use this information to estimate the flow from tank 1 into tank 2, and finally to generate the corresponding control signal. However, more investigation is needed to study this behavior for improving the performance of the closed loop control system.

The future of MPC technology is bright because of its wide application in process industry. For the purpose of dealing with the more complex situations, we may improve the MPC control strategy by using multiple objective functions, predicted reference value, and nonlinear process models in order to better handling the dynamic process.



## BIBLIOGRAPHY

- [1] Giovani Cavalvanti Nunes, “*Design and analysis of multivariable predictive control applied to an oil-water-gas separator*” a polynomial approach”, Dissertation, University of Florida, 2001.
- [2] Bennett, Stuart, “*A history of control engineering, 1930-1955*”, IET, p.p. 48, 1993.
- [3] Clarke, D. W., Mohtadi, C., Tuffs, P. S. “*Generalized Predictive Control – Part I. The Basic Algorithm*”, Automatica, Vol 23, No.2, pp. 137-148, 1987.
- [4] Clarke, D. W., Mohtadi, C., Tuffs, P. S. “*Generalized Predictive Control – Part II. Extensions and Interpretations*”, Automatica, V ol 23, No.2, pp. 149-160, 1987.
- [5] Garcia, C. E., Prett, D. M., Morari, M. “*Model Predictive Control: Theory and Practice – a Survey*”, Automatica, Vol 25, No. 3, pp. 335-348, 1989.
- [6] Camacho, E. F., Bordons, C., “*Model Predictive Control*”, Springer Verlag, London Limited, 2007.
- [7] Mehdra, R. J., Rouhani, R. and Etemo, J., et al, “*Model Algorithmic Control (MAC): Review and Recent Developments*”, Engng Foundation Conf. on Chemical Process Control, Sea Island, Georgia, PP 287- 310.
- [8] Richalet, J. A., A. Rault, J. L Testud and J. Papon, “*Model predictive heuristic control: application to an industrial process*”, Automatica, 14,413-428, 1978.
- [9] C.R. Cutler and B.C. Ramaker, “*Dynamic Matrix Control- A Computer Control Algorithm*”, in Automatic Control Conferencem San Francisco, 1980.
- [10]Rafal, M. D., and W. F. Stevens, “*Discrete Dynamic Optimization Applied to On-Line Optimal Control*”, AICHE H., 14, 1, 85-91 (1968).
- [11]Rawlings,J. B., and K. R. Muske, “*The stability of constrained receding horizon control*”, IEEE Trans. AC, AC-38, 1512-1516 (1993).
- [12]Prett, D.M and M.Morari (Editors), “*Shell Process Control Workshop*”, Butterworths, 1987.

- [13] M. Morshedi, C.R. Cutler, T.A. Skrovanek, “*Optimal solution of dynamic matrix control with linear programming techniques (LDMC)*”, Proc. Amer. Control Conf., Boston, MA, 1985.
- [14] Garcia, C. E., and A. M. Morshedi, “*Quadratic programming solution of dynamic matrix control (QDMC)*”, Chem. Eng. Comm., 46, 73-87, 1986.
- [15] P. J Campo, M. Morari, “Norm Formulation of Model Predictive Control Problems”, Proc. Of the American Control Conf., Seattle, WA, pp. 339-343, 1986.
- [16] J. Richalet, S. Abu el Ata-Doss, C. Arber, H. B. Kuntze, A. Jacobash, and W. Schill, “Predictive Functional Control”, Application to Fast and Accurate Robots. In Proc. 10<sup>th</sup> IFAC Congress, Munich, 1987.
- [17] S. Joe Qin, Thomas A. Badgwell, “*A survey of industrial model predictive control technology*”, Control Engineering Practice 11, 733-764, 2003.
- [18] Wikipedia, “*Model predictive control*”,  
[http://en.wikipedia.org/wiki/Model\\_predictive\\_control](http://en.wikipedia.org/wiki/Model_predictive_control)
- [19] James B. Rawlings, “*Tutorial Overview of Model Predictive Control*”, IEEE Control System Magazine, June 2000.
- [20] J.M. Maciejowski, “*Predictive Control with Constraints*”, Prentice Hall, Harlow, 2001.
- [21] Willy Wojsznis, John Gudaz, Terry Blecins, Ashish Mehta, “*Practical approach to tuning MPC*”, ISA Transactions 42, 149-162, 2003.
- [22] Wikipedia, “*PID controller*”,  
[http://en.wikipedia.org/wiki/PID\\_controller](http://en.wikipedia.org/wiki/PID_controller)
- [23] Carnegie Mellon University, “Control Tutorials for Matlab”,  
<http://www.engin.umich.edu/group/ctm/PID/PID.html#characteristics>
- [24] J. B. Ziegler and N. B. Nichols, “Optimum settings for automatic controllers”, ASME Transactions, v64, pp. 759-768, 1942.
- [25] C. BILELLO, M. DI PAOLA and A. PIRROTTA, “*Time Delay Induced Effects on Control of Non-linear Systems under Random Excitation*”, Meccanica 37: 207-220, 2002.
- [26] Ogata, Katsuhiko, “Discrete-time control systems”, Prentice-Hall. p. 344, 1987.
- [27] Liptak, Bela G., “*Process control and optimization*”, Instrument Engineers Handbook (4<sup>th</sup> Ed.). CRC Press. p.108. 2003.